

Contents		Page
Safety Precautions and Warnings		5
1. OVERVIEW		7
1.1	Description and Features	7
1.2	Options / Accessories	7
1.3	MICRO MASTER and MIDI MASTER Variants	9
1.4	Specifications	10
2. INSTALLATION		13
2.1	Wiring Guidelines to Minimise the Effects of EMI	13
2.2	Mechanical Installation	14
2.3	Electrical Installation – MICRO MASTER	16
2.3.1	Power and Motor Connections	18
2.3.2	Control Connections	19
2.4	Electrical Installation – MIDI MASTER	20
2.4.1	Power and Motor Connections	22
2.4.2	Control Connections	23
3. FRONT PANEL CONTROLS		24
4. OPERATING INFORMATION		26
4.1	General	26
4.2	Basic Operation	26
4.3	Operation – Digital Control	27
4.4	Operation – Analogue Control	27
4.5	Stopping the Motor	27
4.6	If the Motor Does Not Start Up	28
4.7	Local and Remote Control	28
4.8	Closed Loop Control	28
4.8.1	General Description	28
4.8.2	Hardware Setup	29
4.8.3	Parameter Settings	29
5. SYSTEM PARAMETERS		30
6. FAULT CODES		44
7. SUPPLEMENTARY INFORMATION		45
7.1	Application Example	45
7.2	USS Status Codes	45
7.3	Electromagnetic Compatibility (EMC)	46
7.4	European Low Voltage Directive	48
7.5	European Machinery Directive	48
7.6	Technical Terms	49
7.7	Parameter Summary List	50
7.8	User's Parameter Settings	52

Figures

1	MICRO MASTER / MIDI MASTER Block Diagram	8
2	Example of an RFI Suppression Filter Installation	14
3	Mechanical Installation Diagram – MICRO MASTER	14
4	Mechanical Installation Diagram – MIDI MASTER	15
5	The MICRO MASTER – Internal Layout	16
6	Mains Input / Motor Terminal Connections – MICRO MASTER	18
7	Control Connections – MICRO MASTER	19
8	The MIDI MASTER – Internal Layout	21
9	Mains Input / Motor Terminal Connections – MIDI MASTER	22
10	Control Connections – MIDI MASTER	23
11	Front Panel	24
12	IP54 Access Door	24
13	Procedure for Changing Parameter Values	25
14	Motor Rating Plate Example	26
15	Closed Loop Control	29

This page is intentionally blank

Safety Precautions and Warnings

Before installing and putting this equipment into operation, please read these safety precautions and warnings carefully and all the warning signs attached to the equipment. Make sure that the warning signs are kept in a legible condition and replace missing or damaged signs.



WARNING

This equipment contains hazardous voltages and controls hazardous rotating mechanical parts. Loss of life, severe personal injury or property damage can result if the instructions contained in this manual are not followed.



Only suitable qualified personnel should work on this equipment, and only after becoming familiar with all safety notices, installation, operation and maintenance procedures contained in this manual. The successful and safe operation of this equipment is dependent upon its proper handling, installation, operation and maintenance.

- The MICRO MASTER and MIDI MASTER operate at high voltages.
- Only permanently-wired input power connections are allowed. This equipment must be grounded (IEC 536 Class 1, NEC and other applicable standards).
- The dc-link capacitor remains charged to dangerous voltages even when the power is removed. For this reason it is not permissible to open the equipment until five minutes after the power has been turned off. When handling the open equipment it should be noted that live parts are exposed. Do not touch these live parts.
- Machines with a three phase power supply must not be connected to a supply via an ELCB (Earth Leakage Circuit-Breaker – see DIN VDE 0160, section 6.5).
- The following terminals can carry dangerous voltages even if the inverter is inoperative:
 - the power supply terminals L/L2, N/L3 or L1, L/L2, N/L3.
 - the motor terminals W, V, U.
 - the braking resistor / braking unit terminals B+, B- / DC+, DC-.
- Only qualified personnel may connect, start the system up and repair faults. These personnel must be thoroughly acquainted with all the warnings and operating procedures contained in this manual.
- Certain parameter settings may cause the inverter to restart automatically after an input power failure.
- This equipment must not be used as an 'emergency stop' mechanism (*see EN 60204, 9.2.5.4*).



CAUTION

- Children and the general public must be prevented from accessing or approaching the equipment!
- This equipment may only be used for the purpose specified by the manufacturer. Unauthorised modifications and the use of spare parts and accessories that are not sold or recommended by the manufacturer of the equipment can cause fires, electric shocks and injuries.
- Keep these operating instructions within easy reach and give them to all users!

Definitions

- **Qualified Person**

For the purposes of this manual and product labels, a qualified person is one who is familiar with the installation, construction, operation and maintenance of this equipment and with the hazards involved. In addition, the person must be:

- (1) Trained and authorised to energise, de-energise, clear, ground and tag circuits and equipment in accordance with established safety practices.
- (2) Trained in the proper care and use of protective equipment in accordance with established safety practices.
- (3) Trained in rendering first aid.

- **DANGER**

For the purposes of this manual and product labels, DANGER indicates that loss of life, severe personal injury or substantial property damage WILL result if proper precautions are not taken.

- **WARNING**

For the purposes of this manual and product labels, WARNING indicates that loss of life, severe personal injury or substantial property damage CAN result if proper precautions are not taken.

- **CAUTION**

For the purposes of this manual and product labels, CAUTION indicates that minor personal injury or property damage CAN result if proper precautions are not taken.

- **Note**

For the purposes of this manual and product labels, Notes merely call attention to information that is especially significant in understanding and operating the inverter.

1. OVERVIEW

1.1 Description and Features

The MICRO MASTER and MIDI MASTER are a range of inverters with a voltage dc-link circuit for variable speed AC drives (see Figure 1). Various models are available, ranging from the compact 250 W MICRO MASTER up to the 37 kW MIDI MASTER (see section 1.3 below).

Both types of inverter are microprocessor-controlled. A special pulse-width modulation method with selectable pulse frequency permits extremely quiet motor operation. Complete inverter and motor protection is provided by various protective functions.

Features

- Microprocessor-control for reliability and flexibility.
- Remote control capability via RS485 serial link using the USS protocol.
- Ability to control up to 31 inverters via the USS protocol.
- A comprehensive range of parameters is provided to enable the inverters to be configured for use in almost any application.
- Built-in non-volatile memory for storing parameter settings.
- Factory default parameter settings pre-programmed for European and North American requirements.
- Output frequency (and hence motor speed) can be controlled by one of five methods:
 - (1) Digital frequency setpoint
 - (2) Analogue setpoint (voltage or current input)
 - (3) Motor potentiometer
 - (4) Fixed frequency
 - (5) Via remote data transmission
- Built-in dc injection brake.
- Built-in brake chopper for external resistor (MICRO MASTER), optional for MIDI MASTER.
- Integral RFI filter on MM25 – MM220.
- Automatic load compensation by flux current control.
- Built-in ramp generator for variable ramping times.
- Membrane-type front panel controls.
- Two relay outputs incorporated.
- Analogue output incorporated.
- External connection for optional enhanced operator panel or for use as external RS485 interface.
- Closed loop control using a standard Proportional, Integral, Derivative (PID) control loop function.
- Optional protection to IP54 (minimum) for MIDI MASTER inverters.

1.2 Options / Accessories

The following options are available for the MICRO MASTER and MIDI MASTER:

Braking resistor (MICRO MASTER)
 Braking unit (MIDI MASTER)
 RFI suppression filter
 Enhanced operator panel (OPm)
 PROFIBUS module (OPmP)
 SIMOVIS software for control via PC
 Output chokes and line chokes
 Output filters

*Please contact your local
 Siemens sales office for
 further details*

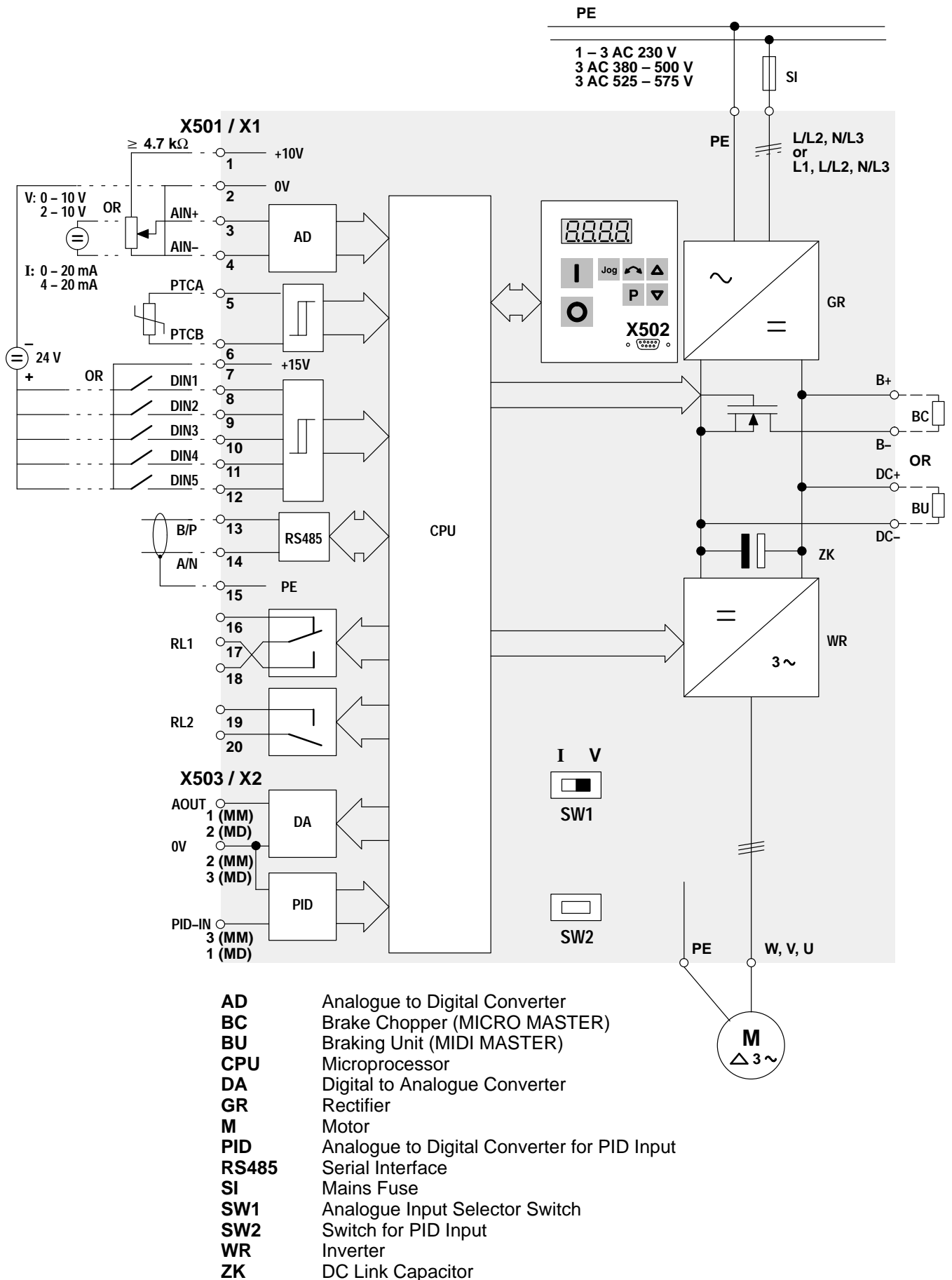

Figure 1: MICRO MASTER / MIDI MASTER Block Diagram

1.3 MICRO MASTER and MIDI MASTER Variants

This handbook covers all variants of the MICRO MASTER and MIDI MASTER inverters, including MIDI MASTER IP54 variants. Differences between IP54 and the standard IP21 MIDI MASTERS are described at the appropriate places in the text.

MICRO MASTER				MIDI MASTER (IP21)			
Model	Input Voltage	Power Rating	Order No.	Model	Input Voltage	Power Rating	Order No.
MM25*	1 AC 230 V	250 W	6SE3111-5BA40	MD550/2	3 AC 230 V	5.5 kW	6SE3122-3CG40
MM37*		370 W	6SE3112-1BA40	MD750/2		7.5 kW	6SE3123-1CG40
MM55*		550 W	6SE3112-8BA40	MD1100/2		11.0 kW	6SE3124-2CH40
MM75*		750 W	6SE3113-6BA40	MD1500/2		15.0 kW	6SE3125-4CH40
MM110		1.1 kW	6SE3115-2BB40	MD1850/2		18.5 kW	6SE3126-8CJ40
MM150		1.5 kW	6SE3116-8BB40	MD2200/2		22.0 kW	6SE3127-5CJ40
MM220		2.2 kW	6SE3121-0BC40	MD750/3		7.5 kW	6SE3121-7DG40
MM25/2*	1/3 AC 230 V	250 W	6SE3111-5CA40	MD1100/3	3 AC 380 – 500 V	11.0 kW	6SE3122-4DG40
MM37/2*		370 W	6SE3112-1CA40	MD1500/3		15.0 kW	6SE3123-0DH40
MM55/2*		550 W	6SE3112-8CA40	MD1850/3		18.5 kW	6SE3123-5DH40
MM75/2*		750 W	6SE3113-6CA40	MD2200/3		22.0 kW	6SE3124-2DJ40
MM110/2		1.1 kW	6SE3115-2CB40	MD3000/3		30.0 kW	6SE3125-5DJ40
MM150/2		1.5 kW	6SE3116-8CB40	MD3700/3		37.0 kW	6SE3126-8DJ40
MM220/2		2.2 kW	6SE3121-0CC40	MD750/4		7.5 kW	6SE3121-1FG40
MM300/2	3.0 kW	6SE3121-3CC40	MD1100/4	11.0 kW	6SE3121-7FG40		
MM150/3	3 AC 380 – 500 V	1.5 kW	6SE3114-0DC40	MD1500/4	3 AC 525 – 575 V	15.0 kW	6SE3122-2FH40
MM220/3		2.2 kW	6SE3115-8DC40	MD1850/4		18.5 kW	6SE3122-7FH40
MM300/3		3.0 kW	6SE3117-3DC40	MD2200/4		22.0 kW	6SE3123-2FJ40
MM400/3		4.0 kW	6SE3121-0DC40	MD3000/4		30.0 kW	6SE3124-1FJ40
MM550/3		5.5 kW	6SE3121-3DC40	MD3700/4		37.0 kW	6SE3125-2FJ40
NOTES				MIDI MASTER (IP54)			
<p>(1) MICRO MASTER models marked "*" do not have an internal fan fitted.</p> <p>(2) All 1 AC 230 V MICRO MASTERS include integrated EMC filters.</p> <p>(3) All 230 V MICRO MASTERS (both 1 and 3 AC) are suitable for 2 AC 230 V operation (MM300/2 requires an external line choke, e.g. 4EM6100-3CB).</p> <p>(4) All 3 AC 230 V MICRO MASTERS can operate on 1 AC 230 V (MM300/2 requires an external line choke, e.g. 4EM6100-3CB).</p> <p>Many aspects of operation are common to all variants. However, some differences do exist (particularly in installation procedures). These differences are described at the appropriate places in the text.</p>				MD550/2-IP54	3 AC 230 V	5.5 kW	6SE3122-3CS45
				MD750/2-IP54		7.5 kW	6SE3123-1CS45
				MD1100/2-IP54		11.0 kW	6SE3124-2CS45
				MD1500/2-IP54		15.0 kW	6SE3125-4CS45
				MD1850/2-IP54		18.5 kW	6SE3126-8CS45
				MD2200/2-IP54		22.0 kW	6SE3127-5CS45
				MD750/3-IP54	3 AC 380 – 500 V	7.5 kW	6SE3121-7DS45
				MD1100/3-IP54		11.0 kW	6SE3122-4DS45
				MD1500/3-IP54		15.0 kW	6SE3123-0DS45
				MD1850/3-IP54		18.5 kW	6SE3123-5DS45
				MD2200/3-IP54		22.0 kW	6SE3124-2DS45
				MD3000/3-IP54		30.0 kW	6SE3125-5DS45
				MD3700/3-IP54	37.0 kW	6SE3126-8DS45	
				MD750/4-IP54	3 AC 525 – 575 V	7.5 kW	6SE3121-1FS45
				MD1100/4-IP54		11.0 kW	6SE3121-7FS45
				MD1500/4-IP54		15.0 kW	6SE3122-2FS45
				MD1850/4-IP54		18.5 kW	6SE3122-7FS45
				MD2200/4-IP54		22.0 kW	6SE3123-2FS45
MD3000/4-IP54	30.0 kW	6SE3124-1FS45					
MD3700/4-IP54	37.0 kW	6SE3125-2FS45					

1.4 Specifications

Single Phase MICRO MASTER Inverters							
Inverter model	MM25	MM37	MM55	MM75	MM110	MM150	MM220
Input voltage range	1 AC 230 V +/-15% 2 AC 208 V +/-10%						
Motor output rating ¹	250 W	370 W	550 W	750 W	1.1 kW	1.5 kW	2.2 kW
Continuous output	660 VA	880 VA	1.14 kVA	1.5 kVA	2.1 kVA	2.8 kVA	4.0 kVA
Output current (nom.)	1.5 A	2.0 A	2.6 A	3.4 A	4.8 A	6.4 A	9.0 A
Output current (max. continuous)	1.6 A	2.3 A	2.9 A	3.7 A	5.2 A	7.0 A	10.0 A
Input current (max.)	3.0 A	3.8 A	5.5 A	6.5 A	14.0 A	18.0 A	20.0 A
Recommended mains fuse	10 A			16 A	20 A		25 A
Recommended lead cross-section (min.)	Input	1.0 mm ²		1.5 mm ²	2.5 mm ²		
	Output	1.0 mm ²			1.5 mm ²		
Dimensions (mm) (w x h x d)	112 x 182 x 113				149 x 184 x 155		185 x 215 x 175
Weight	1.9 kg				2.6 kg		5.0 kg

230 V Three Phase MICRO MASTER Inverters								
Inverter model	MM25/2	MM37/2	MM55/2	MM75/2	MM110/2	MM150/2	MM220/2	MM300/2 ³
Input voltage range	1 – 3 AC 230 V +/-15%							
Motor output rating ¹	250 W	370 W	550 W	750 W	1.1 kW	1.5 kW	2.2 kW	3.0 kW
Continuous output	660 VA	880 VA	1.14 kVA	1.5 kVA	2.1 kVA	2.8 kVA	4.0 kVA	5.2 kVA
Output current (nom.)	1.5 A	2.0 A	2.6 A	3.4 A	4.8 A	6.4 A	9.0 A	11.8 A
Output current (max. continuous)	1.6 A	2.3 A	2.9 A	3.7 A	5.2 A	7.0 A	10.0 A	12.7 A
Input current ² (max.)	2.1 A	3.0 A	4.2 A	5.0 A	7.0 A	9.5 A	12.0 A	14.5 A
Recommended mains fuse ²	10 A			16 A		20 A		
Recommended lead cross-section ² (min.)	Input	1.0 mm ²		1.5 mm ²		2.5 mm ²		
	Output	1.0 mm ²			1.5 mm ²		2.5 mm ²	
Dimensions (mm) (w x h x d)	112 x 182 x 113				149 x 184 x 145		185 x 215 x 162	
Weight	1.8 kg				2.4 kg		4.5 kg	

400 V – 500 V Three Phase MICRO MASTER Inverters					
Inverter model	MM150/3	MM220/3	MM300/3	MM400/3	MM550/3
Input voltage range	3 AC 380 V – 500 V +/-10%				
Motor output rating ¹	1.5 kW	2.2 kW	3.0 kW	4.0 kW	5.5 kW
Continuous output	2.8 kVA	4.0 kVA	5.2 kVA	7.0 kVA	9.0 kVA
Output current (nom.)	3.8 A	5.5 A	7.2 A	9.5 A	12.0 A
Output current (max. continuous)	4.2 A	6.1 A	7.7 A	10.2 A	13.2 A
Input current (max.)	5.5 A	7.5 A	10.0 A	12.5 A	16.0 A
Recommended mains fuse	10 A	16 A		20 A	
Recommended lead cross-section (min.)	Input	1.0 mm ²	1.5 mm ²		2.5 mm ²
	Output	1.0 mm ²			1.5 mm ²
Dimensions (mm) (w x h x d)	185 x 215 x 162				
Weight	5.0 kg				

¹ Siemens 4 pole-motor, 1LA5 series or equivalent.

² Assumes 3-phase supply. If a single or 2-phase supply is used, the input current ratings, wire sizes and fuses for single phase MICRO MASTERS will apply.

³ MM300/2 requires an external choke to operate on a single or 2-phase supply.

230 V Three Phase MIDI MASTER Inverters													
Inverter model	MD550/2		MD750/2		MD1100/2 *		MD1500/2		MD1850/2		MD2200/2		
Constant torque (CT) Variable torque (VT)	CT	VT	CT	VT	CT	VT	CT	VT	CT	VT	CT	VT	
Input voltage range	3 AC 230 V +/-15%												
Motor output rating ¹ (kW)	5.5	7.5	7.5	11.0	11.0	11.0	15.0	18.5	18.5	22.0	22.0	27.0	
Continuous output (kVA)	10.0	12.7	13.1	17.7	17.7	17.7	21.5	25.9	27.5	31.0	32.2	36.0	
Output current (nom.) (A)	22.0	–	28.0	–	42.0	–	54.0	–	68.0	–	80.0	–	
Output current (max. continuous) (A)	22.0	28.0	28.0	42.0	42.0	42.0	54.0	68.0	68.0	80.0	80.0	90.0	
Input current (max.) (A)	38		52		63		76		91		100		
Recommended mains fuse (A)	50		63				80		100				
Recommended lead cross-section (mm ²)	Input (min.)	6		10		16		n/a		25		35	
	Output (min.)	4	6		10		n/a		16		25		35
Dimensions (mm) (w x h x d)	IP21	275 x 450 x 200		275 x 550 x 202				275 x 650 x 278					
	IP54	360 x 675 x 351		360 x 775 x 422				360 x 875 x 483					
Weight (kg)	IP21	20.5		24.0		25.0		28.0		30.0		32.0	
	IP54	30.5		38.0		40.0		50.5		52.5		54.5	

* VT rating is not available on this inverter.

380 V – 500 V Three Phase MIDI MASTER Inverters															
Inverter model	MD750/3		MD1100/3		MD1500/3		MD1850/3		MD2200/3		MD3000/3		MD3700/3		
Constant torque (CT) Variable torque (VT)	CT	VT	CT	VT	CT	VT	CT	VT	CT	VT	CT	VT	CT	VT	
Input voltage range	3 AC 380 V – 500 V +/-10%														
Motor output rating ¹ (kW)	7.5	11.0	11.0	15.0	15.0	18.5	18.5	22.0	22.0	30.0	30.0	37.0	37.0	45.0	
Continuous output (kVA)	12.7	17.7	17.7	21.5	21.5	26.0	26.0	30.8	30.8	40.8	40.8	49.9	49.9	58.0	
Output current (nom.) @ 400 V (A)	16.5	–	23.5	–	30.0	–	37.0	–	43.5	–	58.0	–	70.5	–	
Output current (max. continuous) @ 400 V (A)	19.0	23.5	26.0	30.0	32.0	37.0	38.0	43.5	45.0	58.0	58.0	70.5	72.0	84.0	
Input current (max.) (A)	30		32		41		49		64		79		96		
Recommended mains fuse (A)	32				50				80				100		
Recommended lead cross-section (mm ²)	Input (min.)	6		10		16		25		35					
	Output (min.)	4		6		10		16		25					
Dimensions (mm) (w x h x d)	IP21	275 x 450 x 200			275 x 550 x 202				275 x 650 x 278						
	IP54	360 x 675 x 351			360 x 775 x 422				360 x 875 x 483						
Weight (kg)	IP21	19.5		20.5		24.0		25.0		28.0		30.0		32.0	
	IP54	28.5		30.5		38.0		40.0		50.5		52.5		54.5	

575 V Three Phase MIDI MASTER Inverters															
Inverter model	MD750/4		MD1100/4		MD1500/4		MD1850/4		MD2200/4		MD3000/4		MD3700/4		
Constant torque (CT) Variable torque (VT)	CT	VT	CT	VT	CT	VT	CT	VT	CT	VT	CT	VT	CT	VT	
Input voltage range	3 AC 575 V +/-10%														
Motor output rating ¹ (kW)	7.5	11.0	11.0	15.0	15.0	18.5	18.5	22.0	22.0	30.0	30.0	37.0	37.0	45.0	
Continuous output (kVA)	13.9	16.9	19.4	21.9	23.5	26.9	28.4	31.8	33.6	40.8	44.6	51.7	54.4	61.7	
Output current (nom.) (A)	11.0	–	17.0	–	22.0	–	27.0	–	32.0	–	41.0	–	52.0	–	
Output current (max. continuous) (A)	11.0	17.0	17.0	22.0	22.0	27.0	27.0	32.0	32.0	41.0	41.0	52.0	52.0	62.0	
Input current (max.) (A)	21		26		32		38		48		61		72		
Recommended mains fuse (A)	25		32				40		50		63		80		
Recommended lead cross-section (mm ²)	Input (min.)	4		6		10		10		16		25			
	Output (min.)	2.5		4		6		10		16		16			
Dimensions (mm) (w x h x d)	IP21	275 x 450 x 200			275 x 550 x 202				275 x 650 x 278						
	IP54	360 x 675 x 351			360 x 775 x 422				360 x 875 x 483						
Weight (kg)	IP21	19.5		20.5		24.0		25.0		28.0		30.0		32.0	
	IP54	28.5		30.5		38.0		40.0		50.5		52.5		54.5	

¹ Siemens 4 pole-motor, 1LA5 series or equivalent.

Input frequency:	47 Hz to 63 Hz
Power factor:	$\lambda \geq 0.7$
Output frequency range:	0 Hz to 650 Hz
Resolution:	0.01 Hz
Overload capability:	150% for 60 s, related to nominal current
Protection against:	Inverter overtemperature Motor overtemperature Overvoltage and undervoltage
Additional protection:	Against short-circuits and earth/ground faults pull-out protection Protection against running with no load (open-circuit)
Operating mode:	4 quadrants possible
Regulation and control:	FCC (Flux Current Control) voltage/frequency curve
Analogue setpoint:	0 – 10 V/2 – 10 V (recommended potentiometer 4.7 k Ω) 0 – 20 mA/4 – 20 mA
Analogue setpoint resolution:	10-bit
PID Input:	0 – 5 V/0 – 20 mA (8-bit)
Analogue output:	0 – 20 mA/4 – 20 mA @ 0 – 500 Ω ; stability 5%
Setpoint stability:	Analogue < 1% Digital < 0.02%
Motor temperature monitoring:	PTC input, I ² t control
Ramp times:	0 – 650 s
Control outputs:	2 relays 240 V AC / 1 A; 24 V DC / 2 A WARNING: External inductive loads must be suppressed in an appropriate manner (see section 2.1 (5)).
Interface:	RS485
Inverter efficiency:	97%
Operating temperature:	0°C to +40°C (up to 50°C without cover)
Storage/transport temperature:	–40°C to +70°C
Ventilation:	Convection cooling or fan cooling, depending on power rating
Humidity:	90% non-condensing
Installation height above sea level:	< 1000 m
Degree of protection:	IP21 (NEMA1) (National Electrical Manufacturers' Association) IP54 (minimum) option on MIDI MASTER
Electromagnetic compatibility (EMC):	See section 7.3

2. INSTALLATION



WARNING

THIS EQUIPMENT MUST BE EARTHED.

To guarantee the safe operation of the equipment it must be installed and commissioned properly by qualified personnel in compliance with the warnings laid down in these operating instructions.

Take particular note of the general and regional installation and safety regulations regarding work on high voltage installations (e.g. VDE), as well as the relevant regulations regarding the correct use of tools and personal protective gear.

Make sure that the unobstructed clearance for each of the cooling inlets and outlets above and below the inverter is at least 100 mm (200 mm on all sides for IP54 variants).

Ensure that the temperature does not exceed the specified level when the inverter is installed in a cubicle.

Avoid excessive vibration and shaking of the equipment.

Inverter models MM25 and MM25/2, MM37 and MM37/2, MM55 and MM55/2, and MM75 and MM75/2 **must** be fixed securely to a flat surface before use to prevent access to the capacitors contained within the heatsink.



Note: Consider the possible use of options (e.g. RFI suppression filters) at the planning stage.

2.1 Wiring Guidelines to Minimise the Effects of EMI

The inverters are designed to operate in an industrial environment where a high level of Electro-Magnetic Interference (EMI) can be expected. Usually, good installation practices will ensure safe and trouble-free operation. However, if problems are encountered, the following guidelines may prove useful. In particular, grounding of the system 0V at the inverter, as described below, may prove effective. Figure 2 illustrates how an RFI suppression filter should be installed.

- (1) Ensure that all equipment in the cubicle is well earthed using short, thick earthing cable connected to a common star point or busbar. It is particularly important that any control equipment that is connected to the inverter (such as a PLC) is connected to the same earth or star point as the inverter via a short, thick link. Flat conductors (e.g. metal brackets) are preferred as they have lower impedance at high frequencies.
The return earth from motors controlled by the inverters should be connected directly to the earth connection (PE) on the associated inverter.
- (2) Use saw-tooth washers when mounting the inverter and ensure that a good electrical connection is made between the heatsink and the panel, removing paint if necessary.
- (3) Wherever possible, use screened leads for connections to the control circuitry. Terminate the ends of the cable neatly, ensuring that unscreened wires are not left visible.
- (4) Separate the control cables from the power connections as much as possible, using separate trunking, etc. If control and power cables cross, arrange the cables so that they cross at 90° if possible.
- (5) Ensure that contactors in the cubicle are suppressed, either with R-C suppressors for AC contactors or 'flywheel' diodes for DC contactors, **fitted to the coils**. Varistor suppressors are also effective. This is particularly important if the contactors are controlled from the relays on the inverter.
- (6) Use screened or armoured cables for the power connections and ground the screen at both ends via the cable glands.
- (7) If the drive is to be operated in a noise-sensitive environment, the RFI filter kit should be used to reduce the conducted and radiated interference from the inverter. In this case, the filter should be mounted as close to the inverter as possible and well grounded (*see (2) above*) and the supplied metallised cover should be fitted to the inverter.
- (8) Select the lowest switching frequency possible. This will reduce the amount of EMI generated by the inverter.

On no account must safety regulations be compromised when installing inverters!

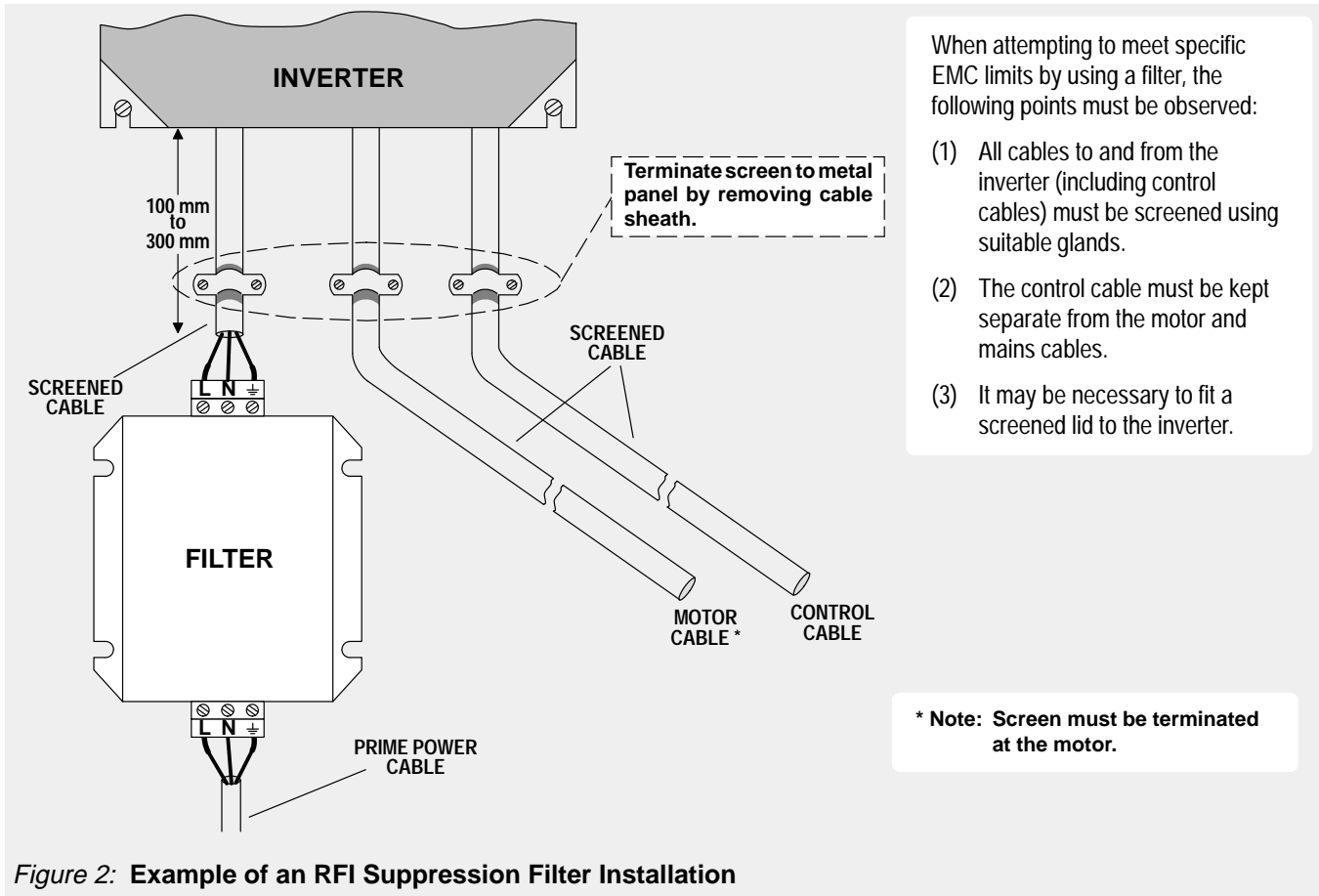
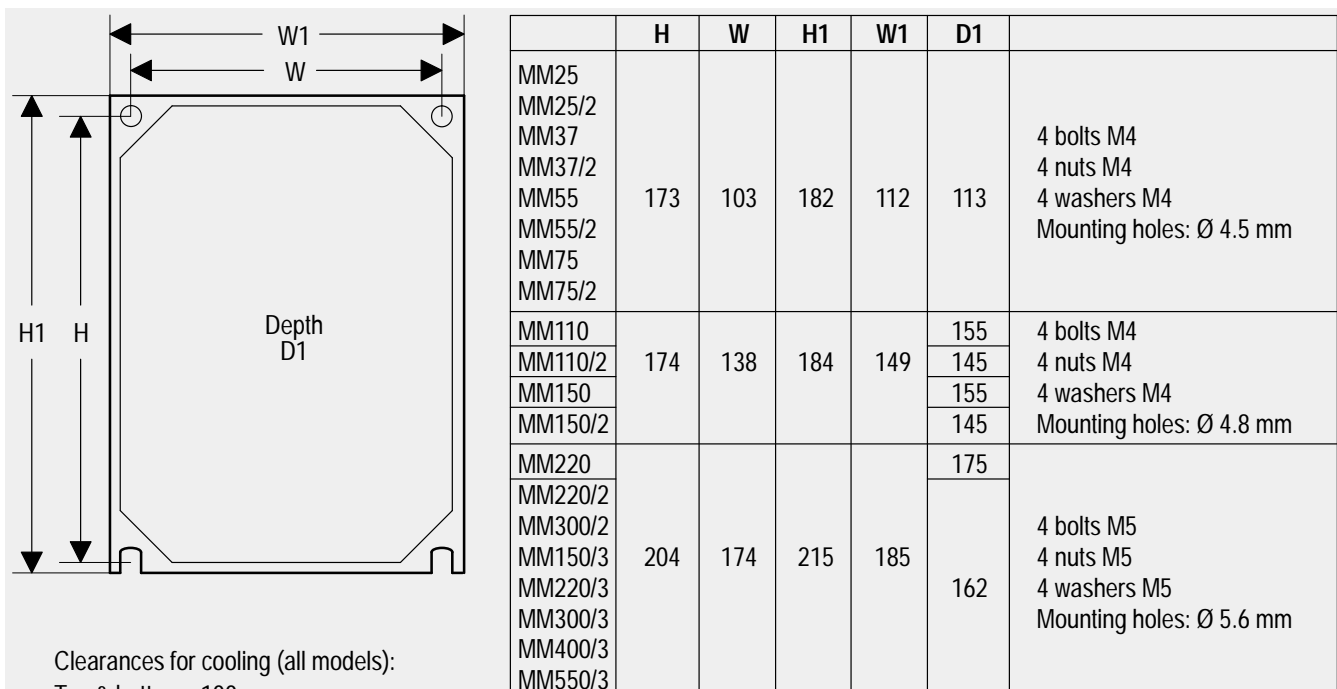

Figure 2: Example of an RFI Suppression Filter Installation

2.2 Mechanical Installation

Mount the MICRO MASTER or MIDI MASTER in accordance with Figure 3 or Figure 4.



Clearances for cooling (all models):
Top & bottom: 100 mm

All measurements in mm.

Figure 3: Mechanical Installation Diagram – MICRO MASTER

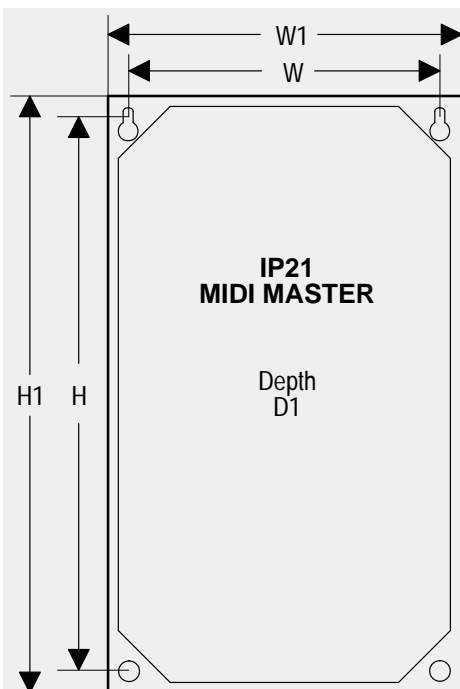

	H	W	H1	W1	D1	FS	
MD550/2 MD750/3 MD1100/3 MD750/4 MD1100/4	430	235	450	275	200	4	4 bolts M8 4 nuts M8 4 washers M8 Mounting holes: Ø 8.5 mm
MD750/2 MD1100/2 MD1500/3 MD1850/3 MD1500/4 MD1850/4	530	235	550	275	202	5	
MD1500/2 MD1850/2 MD2200/2 MD2200/3 MD3000/3 MD3700/3 MD2200/4 MD3000/4 MD3700/4	630	235	650	275	278	6	

Clearances for cooling (all models):
Top & bottom: 100 mm

All measurements in mm.

FS = Frame Size

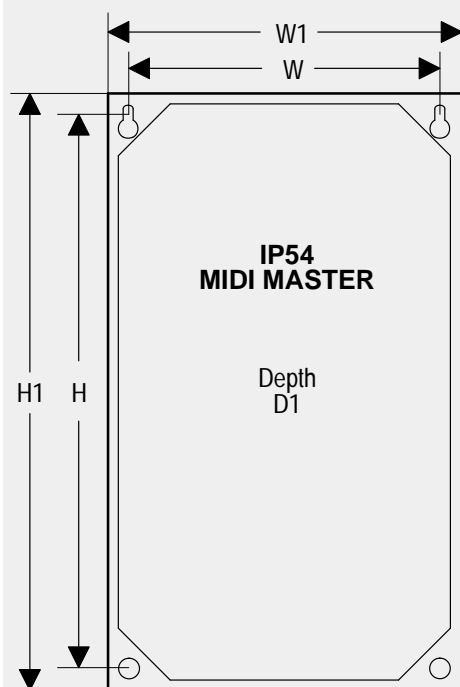

	H	W	H1	W1	D1	FS	
MD550/2-IP54 MD750/3-IP54 MD1100/3-IP54 MD750/4-IP54 MD1100/4-IP54	650	313	675	360	351	4	4 bolts M8 4 nuts M8 4 washers M8 Mounting holes: Ø 8.5 mm
MD750/2-IP54 MD1100/2-IP54 MD1500/3-IP54 MD1850/3-IP54 MD1500/4-IP54 MD1850/4-IP54	750	313	775	360	422	5	
MD1500/2-IP54 MD1850/2-IP54 MD2200/2-IP54 MD2200/3-IP54 MD3000/3-IP54 MD3700/3-IP54 MD2200/4-IP54 MD3000/4-IP54 MD3700/4-IP54	850	313	875	360	483	6	

Clearances for cooling (all models):
Top & bottom and each side: 200 mm

All measurements in mm.

FS = Frame Size

Figure 4: Mechanical Installation Diagram – MIDI MASTER

2.3 Electrical Installation – MICRO MASTER

The cover must be removed to connect the electrical leads. The cover on the MICRO MASTER is attached to the heatsink by a single M4 screw which is located below the STOP button (see Section 3, Figure 11). Remove the screw and then lift off the cover. The electrical terminals are now exposed (see Figure 5).

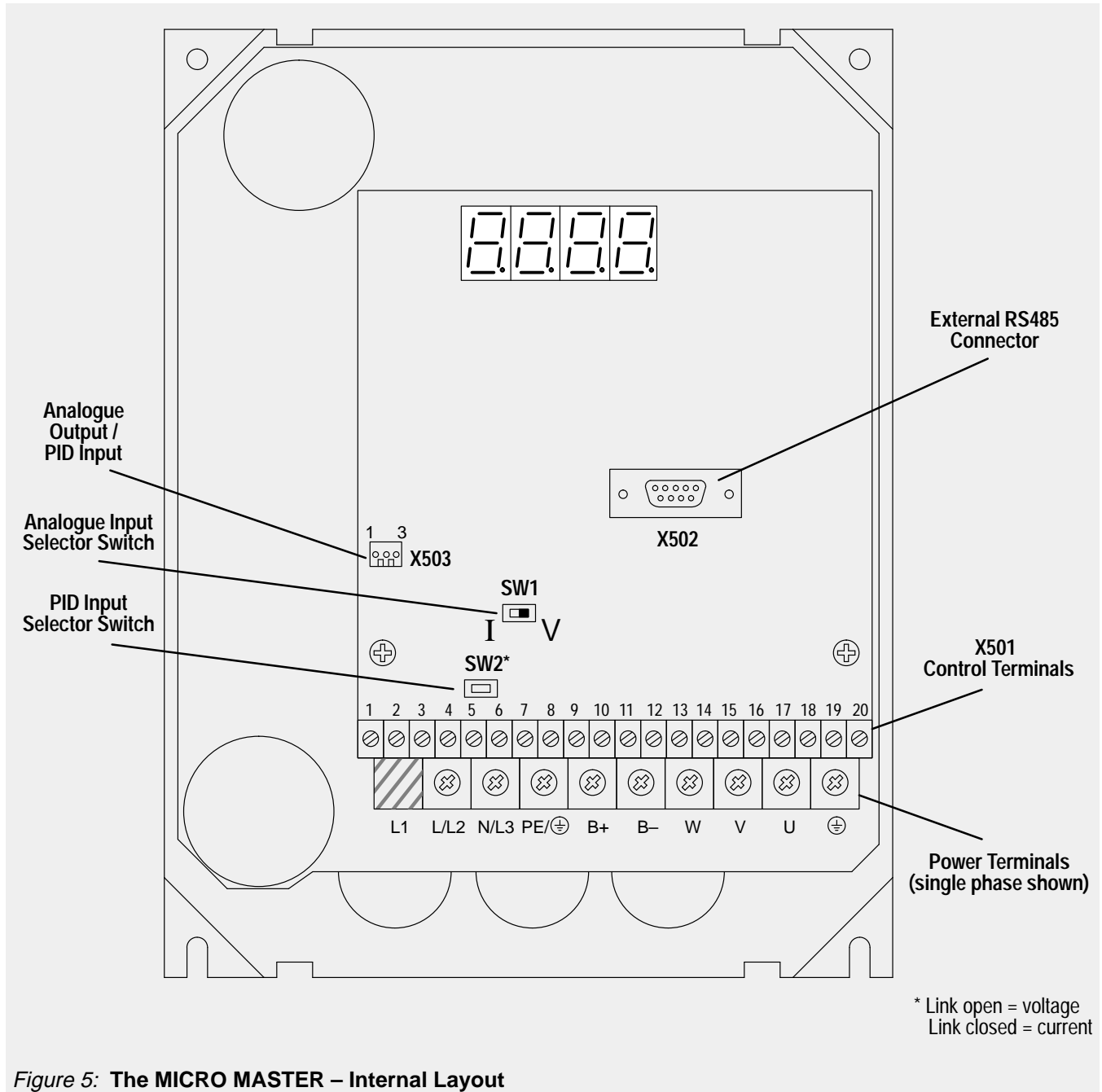

Figure 5: The MICRO MASTER – Internal Layout

**CAUTION**

The printed circuit boards contain CMOS components that are particularly sensitive to static electricity. For this reason, avoid touching the boards or components with your hands or metal objects. Only the terminal screws may be touched with insulated screwdrivers when connecting the cables.

Ensure that the cover is not tilted or skewed when refitted.

Feed the cables into the inverter from the bottom and connect them to the power and control terminal blocks in accordance with the information supplied in sections 2.3.1 and 2.3.2. Ensure that the leads are connected correctly and the equipment is properly earthed.

**CAUTION**

The control, power supply and motor leads must be laid separately. They must not be fed through the same cable conduit/trunking.

Use screened cable for the control lead.

Use Class 1 60/75°C copper wire only. Tightening torque for the field wiring terminals is 1.1 Nm.

Mains Input	Model	Fuse Rating	
1 AC, 230 V	MM25, MM25/2	10 A	
	MM37, MM37/2		
	MM55, MM55/2		
		MM75, MM75/2	16 A
		MM110, MM110/2	20 A
	MM150, MM150/2		
	MM220, MM220/2	25 A	
MM300/2 *	30 A		
3 AC, 230 V	MM25/2	10 A	
	MM37/2		
	MM55/2		
	MM75/2		
		MM110/2	16 A
		MM150/2	
	MM220/2	20 A	
	MM300/2		
3 AC, 380 – 500 V	MM150/3	10 A	
	MM220/3	16 A	
	MM300/3		
	MM400/3	20 A	
	MM550/3		

* *MM300/2 requires an external line choke (4EM6100-3CB).*

To tighten up the terminal screws use: **power terminals** – cross-tip screwdriver 4 – 5 mm
control terminals – small blade screwdriver 2 – 2.5 mm

2.3.1 Power and Motor Connections

Ensure that the power source supplies the correct voltage and is designed for the necessary current (see section 2.3). Ensure that the appropriate circuit-breakers with the specified current rating are connected between the power supply and inverter (see section 1.4).

Connect the power input to the power terminals L/L2 – N/L3 (1 phase) or L1, L/L2, N/L3 (3 phase), and earth using a 3-core cable for single phase units or a 4-core cable for three phase units. For the cross-section of each core see section 1.4.

Use a 4-core cable to connect the motor. As shown in Figure 6, the cable is connected to the power terminals W/V/U and the earth.

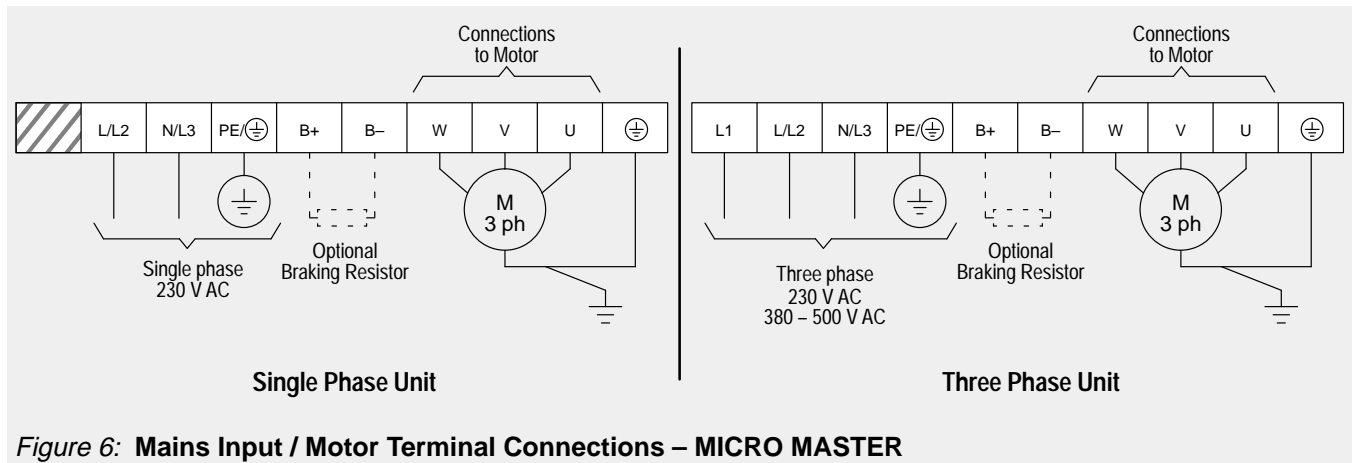

Figure 6: Mains Input / Motor Terminal Connections – MICRO MASTER

The total length of the motor lead should not exceed 50 m. If a screened motor lead is used or if the cable channel is well grounded, the maximum length should be 25 m. Cable lengths up to 200 m are possible by using additional output chokes (see Catalogue DA64).

Asynchronous and synchronous motors can be connected to the MICRO MASTER inverter either individually or in parallel. Note that if a synchronous motor is connected to the inverter, the motor current may be two and a half to three times greater than that expected.



WARNING

Ensure that the motor is configured for the correct supply voltage. **Single/three phase 230 V MICRO MASTERS must not be connected to a 400 V three phase supply.**

When synchronous machines are connected or when coupling several motors in parallel, the inverter must be operated with voltage/frequency control characteristic (P077 = 0 or 2) and slip compensation must be disabled (P071 = 0).

2.3.2 Control Connections

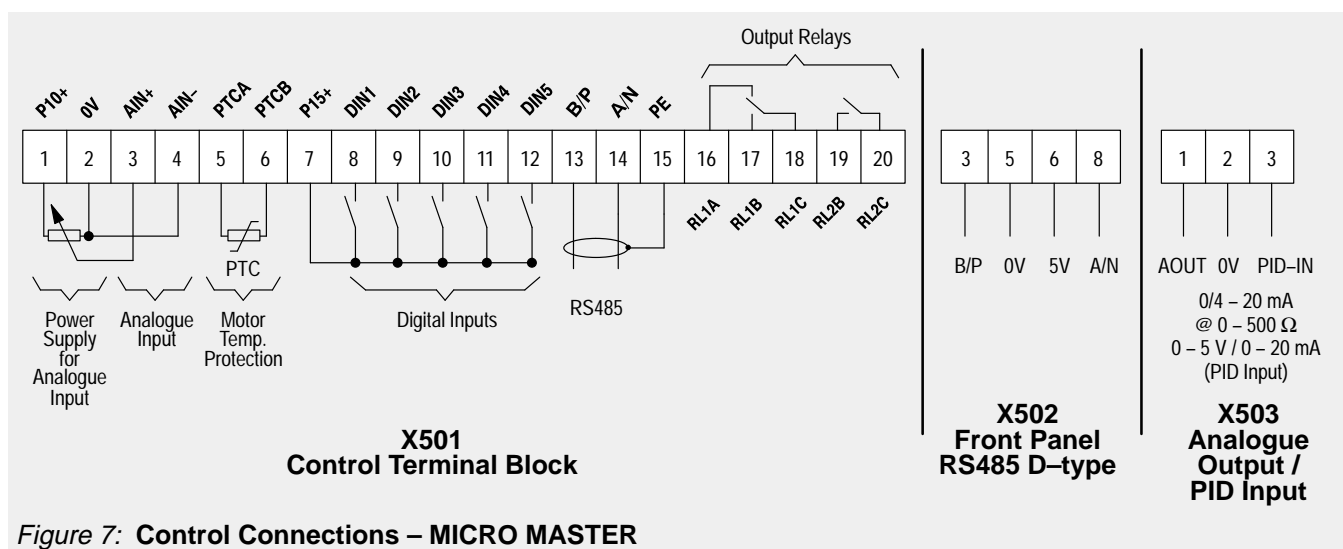

Figure 7: Control Connections – MICRO MASTER

Note: Do not use the internal RS485 connections (terminals 13 and 14) if you intend using the external RS485 connection on the front panel (e.g. to connect an Enhanced Operator Panel (OPm)).

Switch SW1 selects between voltage (V) and current (I) analogue inputs. Switch SW2 selects either a voltage (link open) or current (link closed) PID feedback signal. These switches can only be accessed while the cover is removed (see Figure 5 for location).

Control Terminal (X501)	Description	Value	Function	Notes	
1	P10+	+10 V	Power supply	Max. 3 mA	
2	0V	0 V	Power supply	Ground	
3	AIN+	0 – 10 V/0 – 20 mA or 2 – 10 V/4 – 20 mA	Analogue input	+ connection Input resistance = 300Ω	
4	AIN–		Analogue input	– connection	
5	PTCA		Motor PTC input		
6	PTCB		Motor PTC input		
7	P15+	+15 V	Power supply for DIN1 – 5	Max. 20 mA	
8	DIN1		Digital input 1	13 – 33 V, max. 8 mA	
9	DIN2		Digital input 2	13 – 33 V, max. 8 mA	
10	DIN3		Digital input 3	13 – 33 V, max. 8 mA	
11	DIN4		Digital input 4	13 – 33 V, max. 8 mA	
12	DIN5		Digital input 5	13 – 33 V, max. 8 mA	
13	B/P		RS485 'B' wire (+)	For USS protocol	
14	A/N		RS485 'A' wire (–)	For USS protocol	
15	PE		Protective earth		
16	RL1A		max. 1 A / 230 V AC 2 A / 24 V DC	Relay 1	Normally closed
17	RL1B		Relay 1	Normally open	
18	RL1C		Relay 1	Common	
19	RL2B		max. 1 A / 230 V AC 2 A / 24 V DC	Relay 2	Normally open
20	RL2C		Relay 2	Common	

2.4 Electrical Installation – MIDI MASTER

The cover must be removed to connect the electrical leads. The cover on the MIDI MASTER is attached to the heatsink by four or six M4 screws, depending on the variant. Remove each of the screws and then lift off the cover. The electrical terminals are now exposed (see Figure 8).

Note: The cover on IP54 variants is held in place by four screws. THIS COVER IS HEAVY AND MUST BE SUPPORTED WHILE THE SCREWS ARE REMOVED.



CAUTION

On the printed circuit boards that are now exposed are highly sensitive CMOS components that are particularly sensitive to static electricity. For this reason, avoid touching the boards or components with your hands or metal objects. Only the terminal screws may be touched with insulated screwdrivers when connecting the leads.

The power, control and motor cables enter the inverter from the bottom. When connecting them to the appropriate terminal blocks ensure that they are connected correctly and that the equipment is properly earthed.



CAUTION

The control, power supply and motor leads must be laid separately. They must not be fed through the same cable conduit/trunking.

Use screened cable for the control lead. Use Class 1 60/75°C copper wire only.

Tightening torque for the field wiring terminals is either 1.1 Nm for variants up to 18.5 kW or 2.5 – 3.0 Nm for 22/30/37 kW variants.

Mains Input	Model	Fuse Rating
3 AC, 230 V	MD550/2	50 A
	MD750/2	63 A
	MD1100/2	
	MD1500/2	80 A
	MD1850/2	100 A
	MD2200/2	
3 AC, 380 – 500 V	MD750/3	32 A
	MD1100/3	
	MD1500/3	50 A
	MD1850/3	
	MD2200/3	80 A
	MD3000/3	
	MD3700/3	100 A
3 AC, 525 – 575 V	MD750/4	25 A
	MD1100/4	32 A
	MD1500/4	
	MD1850/4	40 A
	MD2200/4	50 A
	MD3000/4	63 A
	MD3700/4	80 A

To tighten up the terminal screws use: **power terminals** – small or medium blade screwdriver 3 – 7 mm (depends on inverter variant)
control terminals – small blade screwdriver 2 – 2.5 mm

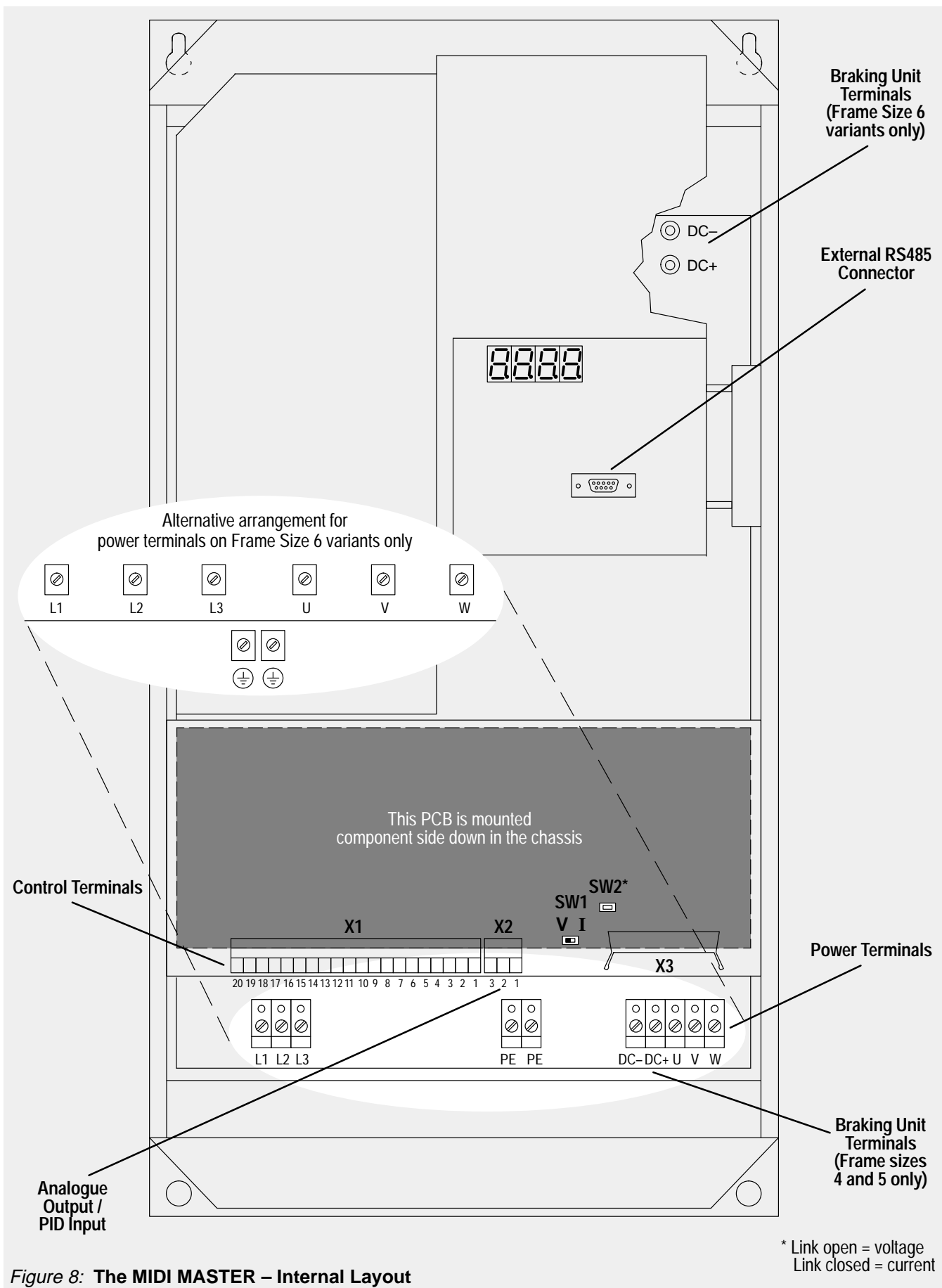

Figure 8: The MIDI MASTER – Internal Layout

2.4.1 Power and Motor Connections

Make sure that the power source supplies the correct voltage and is designed for the necessary current (*see section 2.4*). Ensure that the appropriate circuit-breakers with the specified current rating are connected between the power supply and inverter (*see section 1.4*).

Connect the power input to the power terminals L1, L2, L3 and earth using a 4-core cable. For cross-section of each core see section 1.4.

Use a 4-core cable to connect the motor. As indicated in Figure 9, the cable is connected to the power terminals U/V/W and the separate earth.

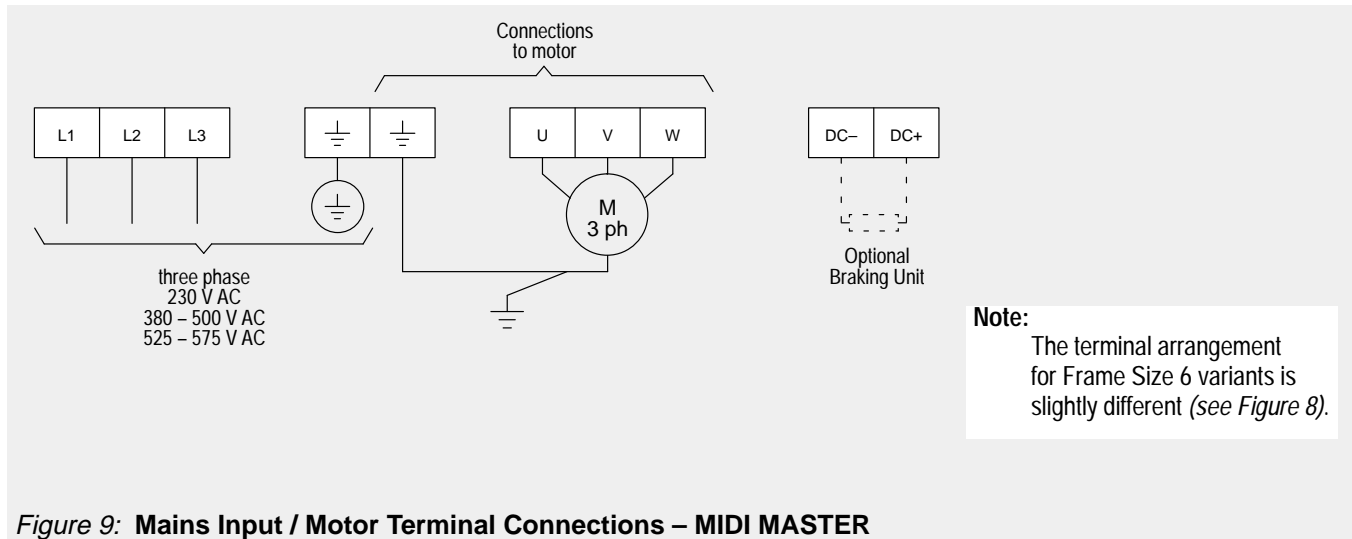

The total length of the motor lead should not exceed 100 m. If a screened motor lead is used or if the cable channel is well grounded, the maximum length should be 50 m. Cable lengths up to 200 m are possible by using additional output chokes (*see Catalogue DA64*).

Asynchronous and synchronous motors can be connected to the MIDI MASTER inverter either individually or in parallel. Note that if a synchronous motor is connected to the inverter, the motor current may be two and a half to three times greater than that expected.



WARNING

Ensure that the motor is configured for correct supply voltage.

When synchronous machines are connected or when coupling several motors in parallel, the inverter must be operated with voltage/frequency control characteristic (P077= 0 or 2) and slip compensation must be disabled (P071 = 0).

2.4.2 Control Connections

These connections are similar to those on the MICRO MASTER (see section 2.3.2), but note the following points:

- (1) The RS485 D-type connector is mounted on a separate PCB.
- (2) The X1 and X2 terminal blocks are of a two-part design. The part containing the screw terminals must be unplugged from its housing on the PCB before the wires can be connected. Once all connections to the terminals have been made, plug the terminal block back into its housing.

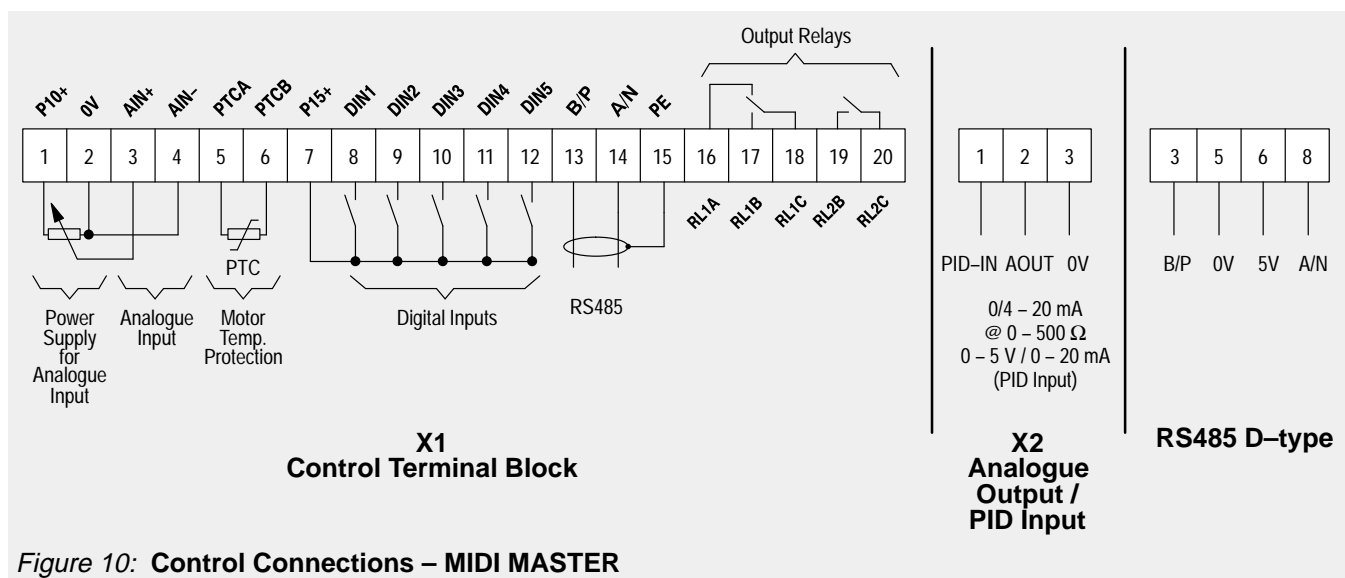

Figure 10: Control Connections – MIDI MASTER

Note: Do not use the internal RS485 connections (terminals 13 and 14) if you intend using the external RS485 connection on the front panel (e.g. to connect an Enhanced Operator Panel (OPm)).

Switch SW1 selects between voltage (V) and current (I) analogue inputs. Switch SW2 selects either a voltage (link open) or current (link closed) PID feedback signal. These switches can only be accessed while the cover is removed (see Figure 8 for location).

3. FRONT PANEL CONTROLS



WARNING

The equipment must not be switched on until after its cover has been fitted.

After the power has been turned off, you must always wait five minutes so that the dc-link capacitors can discharge. Do not remove the cover until this time has elapsed.

As a precautionary measure, the digital frequency setpoint has been set at 0.0 Hz in the factory. This prevents inadvertent and uncontrolled running of the motor occurring at initial start-up.

Before the motor will run it is necessary to enter a frequency setpoint via parameter P000 with the Δ button, or to set it with parameter P005.

All settings must only be entered by qualified personnel, paying particular attention to the safety precautions and warnings.

The parameter settings required can be entered using the three parameterisation buttons (**P**, Δ and ∇) on the front panel of the inverter (Figure 13 contains a flowchart for the procedure for setting parameter values). The parameter numbers and values are indicated on the four digit LED display.

Note: On IP54 MIDI MASTERS the control panel is sealed behind a hinged access door (see Figure 12). To access the panel, undo the four retaining screws and open the access door.



WARNING

IP54 protection is only valid while the access door is closed. If the unit is wet, disconnect the power and wipe the cover dry before opening the door otherwise water may seep inside.

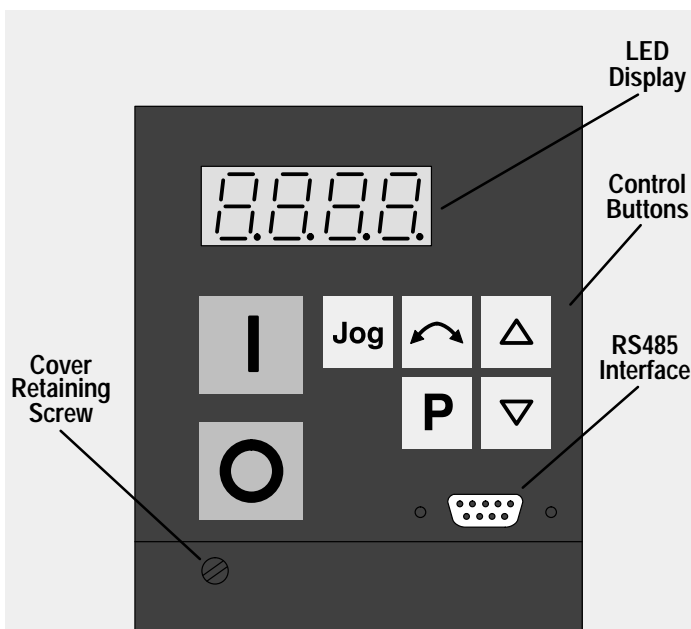

Figure 11: Front Panel

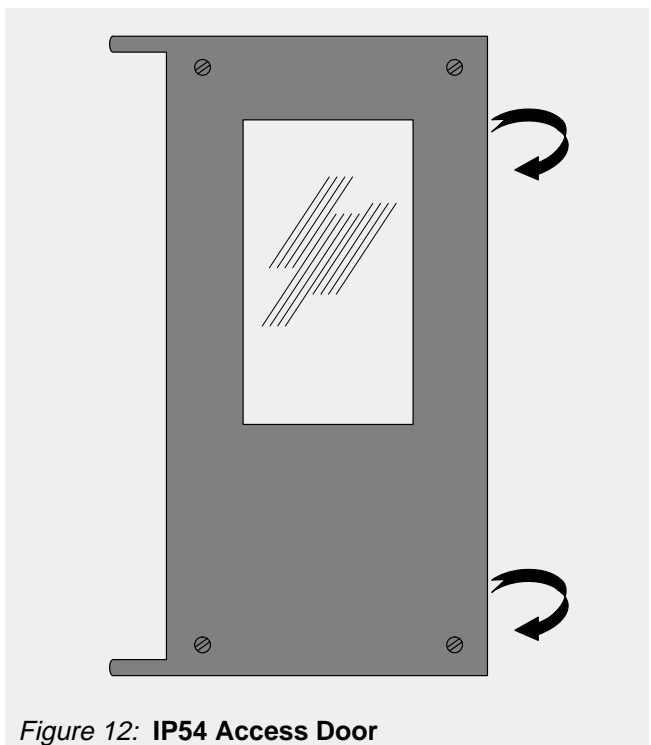









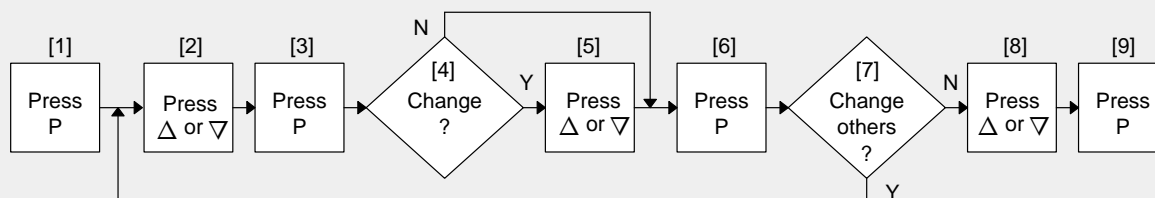

Figure 12: IP54 Access Door

	RUN Button	Press to start the inverter. The operation of this button can be selectively disabled by setting P121 = 0.
	STOP Button	Press to stop the inverter.
	Parameterisation Button	Press to toggle between parameter number and parameter value.
	UP Button	Press to set parameter numbers and parameter values to <i>higher</i> values. The operation of this button can be selectively disabled by setting P124 = 0.
	DOWN Button	Press to set parameter numbers and parameter values to <i>lower</i> values. The operation of this button can be selectively disabled by setting P124 = 0.
	JOG Button	Pressing this button while the inverter is stopped causes it to start and run at the preset frequency. The inverter stops as soon as the button is released. Pressing this button while the inverter is running has no effect. The operation of this button can be selectively disabled by setting P123 = 0.
	FORWARD/REVERSE Button	Press to change the direction of rotation of the motor. If REVERSE is selected, the LED display will indicate this by prefixing a minus sign (-) to the value displayed up to 99.9, or will display a flashing decimal point after the left-hand digit for values of 100.0 or greater. e.g. 60.0 Hz in reverse mode =  120.0 Hz in reverse mode =  The operation of this button can be selectively disabled by setting P122 = 0.

	4-digit LED display	Displays parameter number (P000 – P971), parameter value (000.0 – 999.9) or fault code (F001 – F212). Note: Although the LED display only displays frequency values to a resolution of 0.1 Hz, you can increase the resolution to 0.01 Hz (see Note [6] in Figure 13 for the procedure).
---	---------------------	--

IMPORTANT: Parameters above P009 cannot be adjusted unless P009 is first set to 002 or 003.



Notes

- [1] Display changes to 'P000'.
- [2] Select the parameter to change.
- [3] View the value of the parameter currently selected.
- [4] Do you wish to change the value? If not, go to [6].
- [5] Increase (Δ) or decrease (∇) the value of the parameter.
- [6] 'Lock' the new value into memory (if changed) and return to the parameter display.
Note
To increase the resolution to 0.01 when changing frequency parameters, instead of pressing P momentarily to return to the parameter display, keep the button pressed until the display changes to '-.n0' (n = the current tenths value, e.g. if the parameter value = '055.8' then n = 8). Press Δ or ∇ to change the value (all values between .00 and .99 are valid) and then press P twice to return to the parameter display.
- [7] Do other parameters need changing? If so, return to [2].
- [8] Scroll up or down until 'P971' or 'P000' is displayed. If you scroll upwards, the display stops automatically at P971. However, pressing the Δ button again causes the display to 'wrap around' to P000.
- [9] Exit from the procedure and return to the normal operating display.

If parameters are changed accidentally, all parameters can be reset to their default values by setting parameter **P944** to **1** and then pressing **P**.

Figure 13: Procedure for Changing Parameter Values

4. OPERATING INFORMATION

Refer to the parameter list in section 5 for a full description of each parameter.

4.1 General

- (1) The inverter does not have a main power switch and is therefore live when the mains supply is connected. It waits with the output disabled for the RUN button to be pressed or for an ON signal via terminal 8 (rotate right) or terminal 9 (rotate left) – see parameters P051 – P055.
- (2) If output frequency (P001 = 0) is selected as the display, the corresponding setpoint is displayed approximately every 1.5 seconds while the inverter is stopped.
- (3) The inverter is programmed at the factory for standard applications on Siemens four-pole standard motors. When using other motors it is necessary to enter the specifications from the motor's rating plate into parameters P081 to P085 (see Figure 14). Note that access to these parameters is not possible unless P009 has been set to 002 or 003.

If the inverter is to be used with an 8-pole motor, set P082 to twice the nominal speed of the motor. Be aware that this will cause the display to show twice the real RPM when P001 is set to 005.

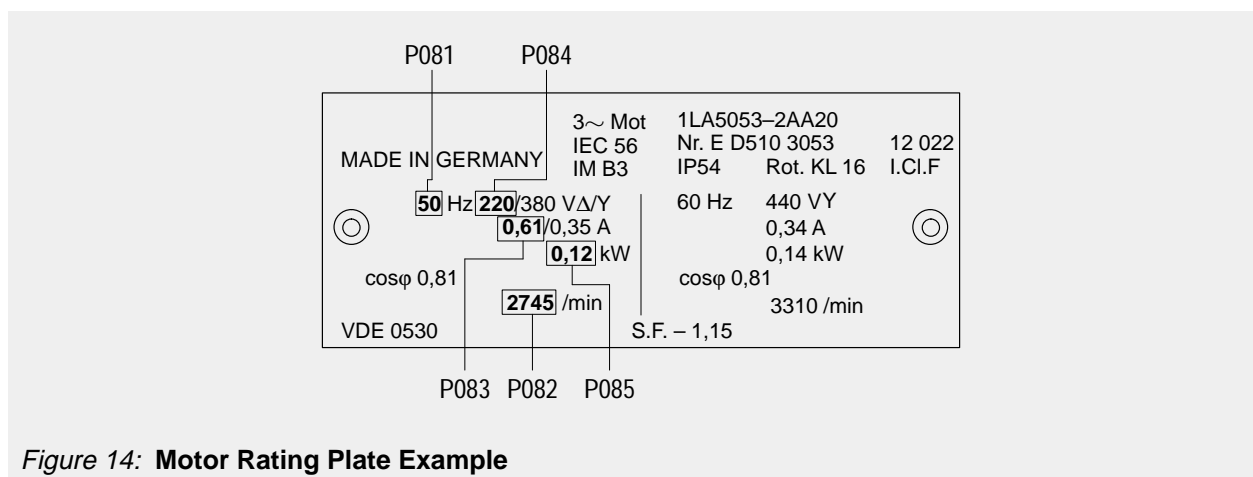

Figure 14: Motor Rating Plate Example

Note: Ensure that the motor is configured correctly, i.e. in the above example connection is for 220 V.

- (4) When delivered, the inverter's frequency setpoint is set to 0.00 Hz, which means that the motor will not rotate! To make it start up, a setpoint must be entered using the Δ button or entering a value in P005.
- (5) When a parameter value has been set, it is stored automatically in the internal memory.

4.2 Basic Operation

The most basic method of setting up the inverter for use is described below. This method uses a digital frequency setpoint and requires only the minimum number of parameters to be changed from their default settings.

- (1) Apply mains power to the inverter. Set parameter P009 to 002 or 003 to enable all parameters to be adjusted (see Figure 13 for the procedure).
- (2) Set parameter P005 to the desired frequency setpoint.
- (3) Check parameters P081 to P085 and ensure that they match the requirements stated on the rating plate on the motor (see Figure 14).
- (4) Press the RUN button (I) on the inverter's front panel. The inverter will now drive the motor at the frequency set by P005.

If required, the motor's speed (i.e. frequency) can be varied directly by using the Δ ∇ buttons. (Set P011 to 001 to enable the new frequency setting to be retained in memory during periods when the inverter is not running.)

4.3 Operation – Digital Control

For a basic startup configuration using digital control, proceed as follows:

- (1) Connect control terminal 7 to terminal 8 via a simple on/off switch. This sets up the inverter for clockwise rotation (default).
- (2) Refit the cover and then apply mains power to the inverter. Set parameter P009 to 002 or 003 to enable all parameters to be adjusted (see *Figure 13 for the procedure*).
- (3) Check that parameter P006 is set to 000 to specify digital setpoint.
- (4) Set parameter P007 to 000 to specify digital input (i.e. DIN1 (terminal 8) in this case) and disable the front panel controls.
- (5) Set parameter P005 to the desired frequency setpoint.
- (6) Set parameters P081 to P085 in accordance with the rating plate on the motor (see *Figure 14*).
- (7) Set the external on/off switch to ON. The inverter will now drive the motor at the frequency set by P005.

4.4 Operation – Analogue Control

For a basic startup configuration using analogue voltage control, proceed as follows:

- (1) Connect control terminal 7 to terminal 8 via a simple on/off switch. This sets up the motor for clockwise rotation (default).
- (2) Connect a 4.7 k Ω potentiometer to the control terminals as shown in Figure 7 (MICRO MASTER) or Figure 10 (MIDI MASTER) or connect a 0 – 10 V signal from pin 2 and pin 4 (0V) to pin 3.
- (3) Set the position of SW1 for voltage (V) input.
- (4) Refit the cover and then apply mains power to the inverter. Set parameter P009 to 002 or 003 to enable all parameters to be adjusted (see *Figure 13 for the procedure*).
- (5) Set parameter P006 to 001 to specify analogue setpoint.
- (6) Set parameter P007 to 000 to specify digital input (i.e. DIN1 (terminal 8) in this case) and disable the front panel controls.
- (7) Set parameters P021 and P022 to specify the minimum and maximum output frequency settings.
- (8) Set parameters P081 to P085 in accordance with the rating plate on the motor (see *Figure 14*).
- (9) Set the external on/off switch to ON. Turn the potentiometer (or adjust the analogue control voltage) until the desired frequency is displayed on the inverter.

4.5 Stopping the Motor

Stopping can be achieved in several ways:

- Cancelling the ON command or pressing the OFF button (O) on the front panel causes the inverter to ramp down at the selected ramp down rate (see *P003*).
- OFF2 – operation causes the motor to coast to a standstill (see *parameters P051 to P055*).
- OFF3 – operation causes rapid braking (see *parameters P051 to P055*).
- DC injection braking up to 250% causes an abrupt stop after cancellation of the ON command (see *P073*).
- Resistive braking (see *parameter P075*).

4.6 If the Motor Does Not Start Up

If the motor does not start up when the ON command has been given, check that the ON command is valid, check if a frequency setpoint has been entered in P005 and check that the motor specifications have been entered correctly under parameters P081 to P085.

If the inverter is configured for operation via the front panel (P007 = 001) and the motor does not start when the RUN button is pressed, check that P121 = 001 (RUN button enabled).

If the motor does not run after parameters have been changed accidentally, reset the inverter to the factory default parameter values by setting parameter **P944** to **001** and then pressing **P**.

4.7 Local and Remote Control

The inverter can be controlled either locally (default), or remotely via a USS data line connected to the internal interface terminals (13 and 14) or to the RS485 D-type connector on the front panel.

When local control is used, the inverter can only be controlled via the front panel or the control terminals. Control commands, setpoints or parameter changes received via the RS485 interface have no effect.

For remote control, the serial interface is designed as a 2-wire connection for bi-directional data transmission. Refer to parameter P910 in section 5 for the available remote control options.

Note: Only one RS485 connection is allowed. You can use either the front panel D-type interface (e.g. to connect an Enhanced Operator Panel (OPm)) or terminals 13 and 14, **but not both**.

When operating via remote control the inverter will not accept control commands from the terminals. *Exception: OFF2 or OFF3 can be activated via parameters P051 to P055 (refer to parameters P051 to P055 in section 5).*

Several inverters can be connected to an external control unit at the same time. The inverters can be addressed individually.

Note: If the inverter has been set up to operate via the serial link but does not run when an ON command is received, try reversing the connections to terminals 13 and 14 on X501 (MICRO MASTER) or X1 (MIDI MASTER).

For further information, refer to the following documents:

E20125-B0001-S302-A1	Application of the USS Protocol in SIMOVERT Units 6SE21 and MICRO MASTER (German)
E20125-B0001-S302-A1-7600	Application of the USS Protocol in SIMOVERT Units 6SE21 and MICRO MASTER (English)

4.8 Closed Loop Control

4.8.1 General Description

Both the MICRO MASTER and MIDI MASTER provide a PID control loop function for closed loop control (see Figure 15). The control loop is ideal for temperature or pressure control, or other situations where the controlled variable changes slowly or where transient errors are not critical. This control loop is **not** suitable for use in systems where fast response times are required.

Note: The closed loop function is not designed for speed control, but can be used for this provided you do not require fast response times.

When closed loop control is enabled (P201 = 001 or 002), all setpoints are calibrated between zero and 100%, i.e. a setpoint of 50.0 = 50%. This allows general purpose control of any process which is actuated by motor speed and for which a suitable transducer is available.

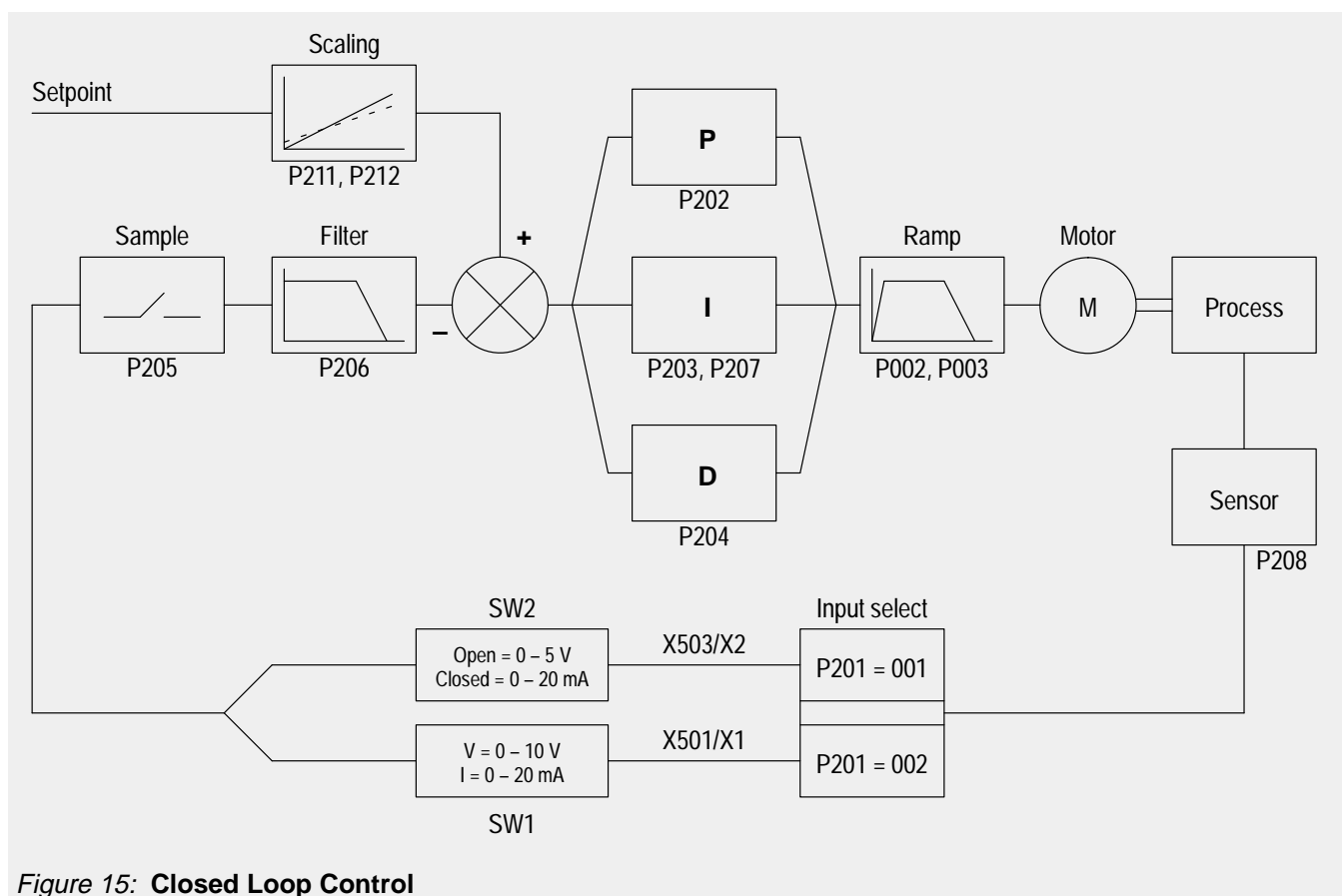

Figure 15: Closed Loop Control

4.8.2 Hardware Setup

Connect the external feedback signal to the dedicated input X503 pin 3 and pin 2 (MICRO MASTER) or X2 pin 1 and pin 3 (MIDI MASTER). This input accepts either a 0 – 5 V or a 0 – 20 mA input (determined by the setting of SW2) and has 8-bit resolution.

If an analogue setpoint is not required, the feedback signal can be connected to X501/X1 terminal 3 and terminal 4. This input accepts either a 0 – 10 V or a 0 – 20 mA input (determined by the setting of SW1), has 10-bit resolution and permits a differential (floating) input. If this option is to be used, the values of parameters P006, P023 and P024 should all be set to 000.

4.8.3 Parameter Settings

Closed loop control cannot be used unless P201 is first set to 001 or 002, depending on the hardware connection point. Most of the parameters associated with closed loop control are shown in Figure 13. Other parameters which are also associated with closed loop control are as follows:

- P001** (value = 007)
- P010** (only if P001 = 007)
- P061** (value = 012 or 013)
- P062** (value = 012 or 013)
- P210**
- P220**

Descriptions of all closed loop control parameters are provided in section 5. For detailed information about PID operation, refer to the Application Note 'PID – Closed Loop Control on MICRO MASTER and MIDI MASTER'.

5. SYSTEM PARAMETERS

Parameters can be changed and set using the membrane-type buttons to adjust the desired properties of the inverter, such as ramp times, minimum and maximum frequencies, etc. The parameter numbers selected and the setting of the parameter values are indicated in the four digit LED display.

Note: If you press the Δ or ∇ button momentarily, the values change step by step. If you keep the buttons pressed for a longer time, the values scroll through rapidly.

Access to parameters is determined by the value set in P009. Check that the key parameters necessary for your application have been programmed.

P009 options are:

- 0 = Only the parameters from P001 to P009 can be read and set.
- 1 = Parameters P001 to P009 can be set and all other parameters can only be read.
- 2 = All parameters can be set, but P009 resets to zero the next time power is removed from the inverter.
- 3 = All parameters can always be set.

Note: In the following parameter table:

- '•' Indicates parameters that can be changed during operation.
- '☆☆☆☆' Indicates that the value of this factory setting depends on the rating of the inverter.

Parameter	Function	Range [Default]	Description / Notes
P000	Operating display	–	This displays the output selected in P001. In the event of a failure, the relevant error message (Fnnn) is displayed (see section 6). In the event of a warning the display flashes. If output frequency has been selected (P001 = 0), the display alternates between the selected frequency and the actual frequency.
P001 •	Display selection	0 – 7 [0]	Display selection: 0 = Output frequency (Hz) 1 = Frequency setpoint (i.e. speed at which inverter is set to run) (Hz) 2 = Motor current (A) 3 = DC-link voltage (V) 4 = Motor torque (% nominal) 5 = Motor RPM 6 = USS status (see section 7.2) 7 = Closed loop display mode Note: The display can be scaled via P010.
P002 •	Ramp up time (seconds)	0 – 650.0 [10.0]	This is the time taken for the motor to accelerate from standstill to the maximum frequency as set in P013. Setting the ramp up time too short can cause the inverter to trip (fault code F002 – overcurrent).

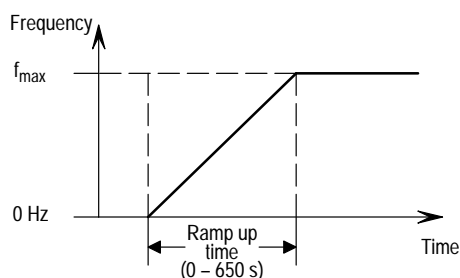

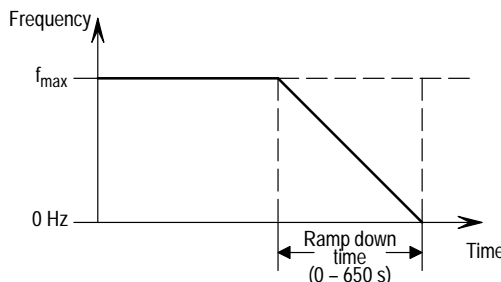
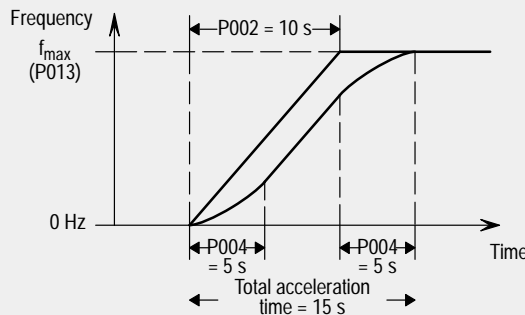
Parameter	Function	Range [Default]	Description / Notes
P003 •	Ramp down time (seconds)	0 – 650.0 [10.0]	This is the time taken for the motor to decelerate from maximum frequency (P013) to standstill. Setting the ramp down time too short can cause the inverter to trip (fault code F001 – overvoltage).
			
P004 •	Smoothing (seconds)	0 – 40.0 [0.0]	Used to smooth the acceleration/deceleration of the motor (useful in applications where it is important to avoid 'jerking', e.g. conveyor systems, textiles, etc.). Smoothing is only effective if the ramp up/down time exceeds 0.3 s.
			
			<p>Note: The smoothing curve for deceleration is based on the ramp up gradient (P002) and is added to the ramp down time set by P003. Therefore, the ramp down time is affected by changes to P002.</p>
P005 •	Digital frequency setpoint (Hz)	0 – 650.00 [0.00]	Sets the frequency that the inverter will run at when operated in digital mode. Only effective if P006 set to '0'.
P006	Frequency setpoint type selection	0 – 2 [0]	Sets the control mode of the inverter: <ul style="list-style-type: none"> 0 = Digital. The inverter runs at the frequency set in P005 and can be adjusted using the Δ and ∇ buttons. Alternatively, if P007 is set to zero, the frequency may be controlled by setting any two of binary inputs P051 – P055 to values of 11 and 12. 1 = Analogue. Control via analogue input signal. 2 = Fixed frequency or motor potentiometer. Fixed frequency is only selected if the value of at least one binary input (P051 – P055) = 6 or 17. Also, the Δ and ∇ buttons can be used to change the fixed frequency setpoint (as with P006 = 0). <p>Note: If P006 = 1 and the inverter is set up for remote control operation, the analogue inputs remain active.</p>
P007	Enable/disable front panel buttons	0 – 1 [1]	<ul style="list-style-type: none"> 0 = RUN, JOG and REVERSE are disabled. Control is via digital inputs (see parameters P051 – P055). Δ and ∇ may still be used to control frequency provided that P124 = 1 and a digital input has not been selected to perform this function. 1 = Front panel buttons can be selectively enabled or disabled depending on the setting of parameters P121 – P124.

Parameter	Function	Range [Default]	Description / Notes
P009 •	Parameter protection setting	0 – 3 [0]	Determines which parameters can be adjusted: 0 = Only parameters from P001 to P009 can be read/set. 1 = Parameters from P001 to P009 can be set and all other parameters can only be read. 2 = All parameters can be read/set but P009 automatically resets to 0 when power is removed. 3 = All parameters can be read/set.
P010	Display scaling	0 – 500.00 [1.00]	Scale factor for display selected via P001.
P011	Frequency setpoint memory	0 – 1 [0]	0 = Disabled 1 = Enabled after switch-off. i.e. The setpoint alterations made with the Δ / ∇ buttons are stored even when power has been removed from the inverter.
P012 •	Minimum motor frequency (Hz)	0 – 650.00 [0.00]	Sets the minimum motor frequency (must be less than the value of P013).
P013 •	Maximum motor frequency (Hz)	0 – 650.00 [50.00]	Sets the maximum motor frequency.
P014 •	Skip frequency (Hz)	0 – 650.00 [0.00]	A skip frequency can be set with this parameter to avoid the effects of resonance of the inverter. Frequencies within +/-2 Hz of this setting are suppressed. Stationary operation is not possible within the suppressed frequency range – the range is just passed through.
P015 •	Automatic restart	0 – 1 [0]	Setting this parameter to '1' enables the inverter to restart automatically after a mains break or 'brownout', provided the run/stop switch is still closed. 0 = Disabled 1 = Automatic restart
P016 •	Start on the fly	0 – 4 [0]	Allows the inverter to start onto a spinning motor. Under normal circumstances the inverter runs the motor up from 0 Hz. However, if the motor is still spinning or is being driven by the load, it will undergo braking before running back up to the setpoint – this can cause an overcurrent trip. By using a flying restart, the inverter 'homes in' on the motor's speed and runs it up from that speed to the setpoint. (Note: If the motor has stopped or is rotating slowly, some 'rocking' may occur as the inverter senses the direction of rotation prior to restarting.) 0 = Normal restart 1 = Flying restart after power up, fault or OFF2 (if P018 = 1). 2 = Flying restart every time (useful in circumstances where the motor can be driven by the load). 3 = As P016 = 1 except that the inverter will only attempt to restart the motor in the direction of the requested setpoint. The motor is prevented from 'rocking' backwards and forwards during the initial frequency scan. 4 = As P016 = 2 except that the inverter will only attempt to restart the motor in the direction of the requested setpoint. The motor is prevented from 'rocking' backwards and forwards during the initial frequency scan. Note: For MIDI MASTER units, it is recommended that P018 is set to '1' if P016 is set to any value other than zero. This will ensure correct restarting on occasions when the inverter fails to re-synchronise on the initial attempt.

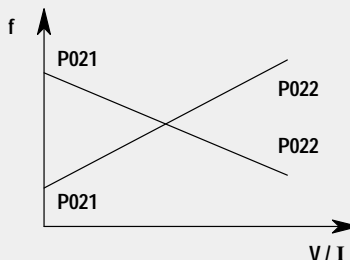
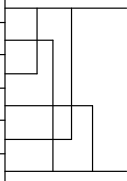
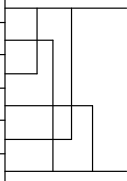
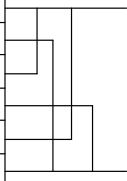
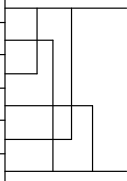
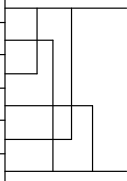
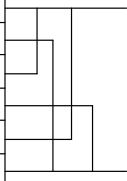
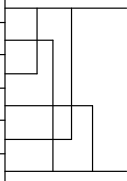
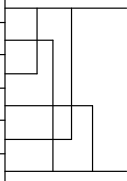
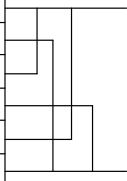
Parameter	Function	Range [Default]	Description / Notes												
P017 •	Smoothing type	1 – 2 [1]	<p>1 = Continuous smoothing (as defined by P004). 2 = Discontinuous smoothing. This provides a fast unsmoothed response to STOP commands.</p> <p>Note: P004 must be set to a value > 0.0 for this parameter to have any effect.</p>												
P018 •	Automatic restart after fault	0 – 1 [0]	<p>Automatic restart after fault: 0 = Disabled 1 = The inverter will attempt to restart up to 5 times after a fault. If the fault is not cleared after the 5th attempt, the inverter will remain in the fault state.</p>												
P021 •	Minimum analogue frequency (Hz)	0 – 650.00 [0.00]	Frequency corresponding to the lowest analogue input value, i.e. 0 V/0 mA or 2 V/4 mA, determined by P023. This can be set to a higher value than P022 to give an inverse relationship between analogue input and frequency output (see diagram in P022).												
P022 •	Maximum analogue frequency (Hz)	0 – 650.00 [50.00]	<p>Frequency corresponding to the highest analogue input value, i.e. 10 V or 20 mA, determined by P023. This can be set to a lower value than P021 to give an inverse relationship between analogue input and frequency output.</p> <p>i.e.</p> 												
P023 •	Analogue input type	0 – 2 [0]	<p>Sets analogue input type, depending on the position of switch SW1:</p> <table border="1" data-bbox="837 1142 1173 1344"> <tbody> <tr> <td rowspan="2">P023 = 0</td> <td>0 V – 10 V</td> <td rowspan="2">  </td> </tr> <tr> <td>0 mA – 20 mA</td> </tr> <tr> <td rowspan="2">P023 = 1</td> <td>2 V – 10 V</td> <td rowspan="2">  </td> </tr> <tr> <td>4 mA – 20 mA</td> </tr> <tr> <td rowspan="2">P023 = 2</td> <td>2 V* – 10 V</td> <td rowspan="2">  </td> </tr> <tr> <td>4 mA* – 20 mA</td> </tr> </tbody> </table> <p>* The inverter will come to a controlled stop if $V < 1\text{ V}$ or $I < 2\text{ mA}$.</p> <p>Notes: (1) Setting P023 = 2 will not work unless the inverter is under full local control (i.e. P910 = 0 or 4). (2) For failsafe operation (e.g. to protect against a break in the control wire), select <u>current</u> input.</p>	P023 = 0	0 V – 10 V		0 mA – 20 mA	P023 = 1	2 V – 10 V		4 mA – 20 mA	P023 = 2	2 V* – 10 V		4 mA* – 20 mA
P023 = 0	0 V – 10 V														
	0 mA – 20 mA														
P023 = 1	2 V – 10 V														
	4 mA – 20 mA														
P023 = 2	2 V* – 10 V														
	4 mA* – 20 mA														
P024 •	Analogue setpoint addition	0 – 2 [0]	<p>If the inverter is not in analogue mode (P006 = 0 or 2), setting this parameter to '1' causes the analogue input value to be added.</p> <p>0 = No addition 1 = Addition of the analogue setpoint to the fixed frequency or the motor potentiometer frequency. 2 = Scaling of digital/fixed setpoint by analogue input in the range 0 – 100%.</p> <p>Note: By selecting a combination of reversed negative fixed frequency settings and analogue setpoint addition, it is possible to configure the inverter for 'centre zero' operation with a +/-5 V supply or a 0 – 10 V potentiometer so that the output frequency can be 0 Hz at any position, including the centre position.</p>												

	<p>WARNING</p> <p>Setting P023 = 2 with no connections between X1.3 and X1.4 (MIDI MASTER) or X501.3 and X501.4 (MICRO MASTER) will cause the inverter to run immediately.</p>
---	---

Parameter	Function	Range [Default]	Description / Notes																														
P025 •	Analogue output	0 – 105 [0]	This provides a method of scaling the analogue output in accordance with the following table:																														
<table border="1"> <thead> <tr> <th rowspan="2"></th> <th rowspan="2">Selection</th> <th colspan="2">Analogue Output Range Limits</th> </tr> <tr> <th>0/4 mA</th> <th>20 mA</th> </tr> </thead> <tbody> <tr> <td>0/100</td> <td>Output frequency</td> <td>0 Hz</td> <td>Output frequency (P013)</td> </tr> <tr> <td>1/101</td> <td>Frequency setpoint</td> <td>0 Hz</td> <td>Frequency setpoint (P013)</td> </tr> <tr> <td>2/102</td> <td>Motor current</td> <td>0 A</td> <td>Max. overload current (P083 x P086 / 100)</td> </tr> <tr> <td>3/103</td> <td>DC-link voltage</td> <td>0 V</td> <td>1023 Vdc</td> </tr> <tr> <td>4/104</td> <td>Motor torque</td> <td>-250%</td> <td>+250% (100% = P085 / P082 x 9.55 Nm)</td> </tr> <tr> <td>5/105</td> <td>Motor RPM</td> <td>0</td> <td>Nominal motor RPM (P082)</td> </tr> </tbody> </table>					Selection	Analogue Output Range Limits		0/4 mA	20 mA	0/100	Output frequency	0 Hz	Output frequency (P013)	1/101	Frequency setpoint	0 Hz	Frequency setpoint (P013)	2/102	Motor current	0 A	Max. overload current (P083 x P086 / 100)	3/103	DC-link voltage	0 V	1023 Vdc	4/104	Motor torque	-250%	+250% (100% = P085 / P082 x 9.55 Nm)	5/105	Motor RPM	0	Nominal motor RPM (P082)
	Selection	Analogue Output Range Limits																															
		0/4 mA	20 mA																														
0/100	Output frequency	0 Hz	Output frequency (P013)																														
1/101	Frequency setpoint	0 Hz	Frequency setpoint (P013)																														
2/102	Motor current	0 A	Max. overload current (P083 x P086 / 100)																														
3/103	DC-link voltage	0 V	1023 Vdc																														
4/104	Motor torque	-250%	+250% (100% = P085 / P082 x 9.55 Nm)																														
5/105	Motor RPM	0	Nominal motor RPM (P082)																														
<p>Note: Use range 0 – 5 if minimum output value = 0 mA Use range 100 – 105 if minimum output value = 4 mA</p>																																	
P031 •	Jog frequency right (Hz)	0 – 650.00 [5.00]	Jogging is used to advance the motor by small amounts. It is controlled via the JOG button or with a non-latching switch on one of the digital inputs (P051 to P055). If jog right is enabled (DINn = 7), this parameter controls the frequency at which the inverter will run when the switch is closed. Unlike other setpoints, it can be set lower than the minimum frequency.																														
P032 •	Jog frequency left (Hz)	0 – 650.00 [5.00]	If jog left is enabled (DINn = 8), this parameter controls the frequency at which the inverter will run when the switch is closed. Unlike other setpoints, it can be set lower than the minimum frequency.																														
P033 •	Jog ramp up time (seconds)	0 – 650.0 [10.0]	This is the time taken to accelerate from 0 Hz to maximum frequency (P013) for jog functions. It is <u>not</u> the time taken to accelerate from 0 Hz to the jog frequency. If DINn = 16 (see P051 – P055) then this parameter can be used to override the normal ramp up time set by P002.																														
P034 •	Jog ramp down time (seconds)	0 – 650.0 [10.0]	This is the time taken to decelerate from maximum frequency (P013) to 0 Hz for jog functions. It is <u>not</u> the time taken to decelerate from the jog frequency to 0 Hz. If DINn = 16 (see P051 – P055) then this parameter can be used to override the normal ramp down time set by P003.																														
P041 •	1st fixed frequency (Hz)	0 – 650.00 [5.00]	Valid if P006 = 2 and P055 = 6.																														
P042 •	2nd fixed frequency (Hz)	0 – 650.00 [10.00]	Valid if P006 = 2 and P054 = 6.																														
P043 •	3rd fixed frequency (Hz)	0 – 650.00 [20.00]	Valid if P006 = 2 and P053 = 6.																														
P044 •	4th fixed frequency (Hz)	0 – 650.00 [40.00]	Valid if P006 = 2 and P052 = 6.																														

Parameter	Function	Range [Default]	Description / Notes
-----------	----------	--------------------	---------------------

P045 Inversion fixed setpoints for fixed frequencies 1 – 4 0 – 7 [0] Sets the direction of rotation for the fixed frequency:

	FF 1	FF 2	FF 3	FF 4
P045 = 0	⇒	⇒	⇒	⇒
P045 = 1	⇐	⇒	⇒	⇒
P045 = 2	⇒	⇐	⇒	⇒
P045 = 3	⇒	⇒	⇐	⇒
P045 = 4	⇒	⇒	⇒	⇐
P045 = 5	⇐	⇐	⇒	⇒
P045 = 6	⇐	⇐	⇐	⇒
P045 = 7	⇐	⇐	⇐	⇐

⇒ Fixed setpoints not inverted

⇐ Fixed setpoints inverted

P046 • 5th fixed frequency (Hz) 0 – 650.00 [0.00] Valid if P006 = 2 and P053 or P054 or P055 = 17.

P047 • 6th fixed frequency (Hz) 0 – 650.00 [0.00] Valid if P006 = 2 and P053 or P054 or P055 = 17.

P048 • 7th fixed frequency (Hz) 0 – 650.00 [0.00] Valid if P006 = 2 and P053 or P054 or P055 = 17.

P049 • 8th fixed frequency (Hz) 0 – 650.00 [0.00] Valid if P006 = 2 and P053 or P054 or P055 = 17.

P050 Inversion fixed setpoints for fixed frequencies 5 – 8 0 – 7 [0] Sets the direction of rotation for the fixed frequency:

	FF 5	FF 6	FF 7	FF 8
P050 = 0	⇒	⇒	⇒	⇒
P050 = 1	⇐	⇒	⇒	⇒
P050 = 2	⇒	⇐	⇒	⇒
P050 = 3	⇒	⇒	⇐	⇒
P050 = 4	⇒	⇒	⇒	⇐
P050 = 5	⇐	⇐	⇒	⇒
P050 = 6	⇐	⇐	⇐	⇒
P050 = 7	⇐	⇐	⇐	⇐

⇒ Fixed setpoints not inverted

⇐ Fixed setpoints inverted

Parameter	Function	Range [Default]	Description / Notes																																																																																
P051	Selection control function, DIN1 (terminal 8), fixed frequency 5.	0 – 18 [1]	<table border="1"> <thead> <tr> <th>Value</th> <th>Function of P051 to P055</th> <th>Function, low state</th> <th>Function, high state</th> </tr> </thead> <tbody> <tr> <td>0</td> <td>Input disabled</td> <td>–</td> <td>–</td> </tr> <tr> <td>1</td> <td>ON right</td> <td>Off</td> <td>On right</td> </tr> <tr> <td>2</td> <td>ON left</td> <td>Off</td> <td>On left</td> </tr> <tr> <td>3</td> <td>Reverse</td> <td>Normal</td> <td>Reverse</td> </tr> <tr> <td>4</td> <td>OFF2</td> <td>OFF2</td> <td>On</td> </tr> <tr> <td>5</td> <td>OFF3</td> <td>OFF3</td> <td>On</td> </tr> <tr> <td>6</td> <td>Fixed frequencies 1 – 5</td> <td>Off</td> <td>On</td> </tr> <tr> <td>7</td> <td>Jog right</td> <td>Off</td> <td>Jog right</td> </tr> <tr> <td>8</td> <td>Jog left</td> <td>Off</td> <td>Jog left</td> </tr> <tr> <td>9</td> <td>Remote operation</td> <td>Local</td> <td>Remote</td> </tr> <tr> <td>10</td> <td>Fault code reset</td> <td>Off</td> <td>Reset on rising edge</td> </tr> <tr> <td>11</td> <td>Increase frequency *</td> <td>Off</td> <td>Increase</td> </tr> <tr> <td>12</td> <td>Decrease frequency *</td> <td>Off</td> <td>Decrease</td> </tr> <tr> <td>13</td> <td>Disable analogue input (setpoint is 0.0 Hz)</td> <td>Analogue on</td> <td>Analogue disabled</td> </tr> <tr> <td>14</td> <td>Disable 'P' button</td> <td>'P' enabled</td> <td>'P' disabled</td> </tr> <tr> <td>15</td> <td>Enable dc brake</td> <td>Off</td> <td>Brake on</td> </tr> <tr> <td>16</td> <td>Use jog ramp times instead of normal ramp times</td> <td>Normal</td> <td>Jog ramp times</td> </tr> <tr> <td>17</td> <td>Binary fixed frequency control (fixed frequencies 1 – 8) **</td> <td>Off</td> <td>On</td> </tr> <tr> <td>18</td> <td>As 6, but input high will also request RUN</td> <td>Off</td> <td>On</td> </tr> </tbody> </table>	Value	Function of P051 to P055	Function, low state	Function, high state	0	Input disabled	–	–	1	ON right	Off	On right	2	ON left	Off	On left	3	Reverse	Normal	Reverse	4	OFF2	OFF2	On	5	OFF3	OFF3	On	6	Fixed frequencies 1 – 5	Off	On	7	Jog right	Off	Jog right	8	Jog left	Off	Jog left	9	Remote operation	Local	Remote	10	Fault code reset	Off	Reset on rising edge	11	Increase frequency *	Off	Increase	12	Decrease frequency *	Off	Decrease	13	Disable analogue input (setpoint is 0.0 Hz)	Analogue on	Analogue disabled	14	Disable 'P' button	'P' enabled	'P' disabled	15	Enable dc brake	Off	Brake on	16	Use jog ramp times instead of normal ramp times	Normal	Jog ramp times	17	Binary fixed frequency control (fixed frequencies 1 – 8) **	Off	On	18	As 6, but input high will also request RUN	Off	On
Value	Function of P051 to P055	Function, low state		Function, high state																																																																															
0	Input disabled	–		–																																																																															
1	ON right	Off		On right																																																																															
2	ON left	Off		On left																																																																															
3	Reverse	Normal		Reverse																																																																															
4	OFF2	OFF2		On																																																																															
5	OFF3	OFF3		On																																																																															
6	Fixed frequencies 1 – 5	Off		On																																																																															
7	Jog right	Off		Jog right																																																																															
8	Jog left	Off		Jog left																																																																															
9	Remote operation	Local		Remote																																																																															
10	Fault code reset	Off		Reset on rising edge																																																																															
11	Increase frequency *	Off		Increase																																																																															
12	Decrease frequency *	Off		Decrease																																																																															
13	Disable analogue input (setpoint is 0.0 Hz)	Analogue on		Analogue disabled																																																																															
14	Disable 'P' button	'P' enabled		'P' disabled																																																																															
15	Enable dc brake	Off		Brake on																																																																															
16	Use jog ramp times instead of normal ramp times	Normal	Jog ramp times																																																																																
17	Binary fixed frequency control (fixed frequencies 1 – 8) **	Off	On																																																																																
18	As 6, but input high will also request RUN	Off	On																																																																																
P052	Selection control function, DIN2 (terminal 9), fixed frequency 4	0 – 18 [2]																																																																																	
P053	Selection control function, DIN3 (terminal 10), fixed frequency 3. If set to 17, this enables the most significant bit of the 3-bit BCD (see table).	0 – 18 [6]																																																																																	
P054	Selection control function, DIN4 (terminal 11), fixed frequency 2. If set to 17, this enables the middle bit of the 3-bit BCD (see table).	0 – 18 [6]																																																																																	
P055	Selection control function, DIN5 (terminal 12), fixed frequency 1. If set to 17, this enables the least significant bit of the 3-bit BCD (see table).	0 – 18 [6]																																																																																	

* Only effective when P007 = 0.
 ** Not available on P051 or P052.

Binary Coded Fixed Frequency Mapping

	DIN3 (P053)	DIN4 (P054)	DIN5 (P055)
FF5 (P046)	0	0	0
FF6 (P047)	0	0	1
FF7 (P048)	0	1	0
FF8 (P049)	0	1	1
FF1 (P041)	1	0	0
FF2 (P042)	1	0	1
FF3 (P043)	1	1	0
FF4 (P044)	1	1	1

Note: If P051 or P052 = 6 or 18 while P053 or P054 or P055 = 17 then the setpoints are added.

Examples: (1) P053 = 17, P054 = 17, P055 = 17:
 All 8 fixed frequencies are available
 e.g. DIN3 = 1, DIN4 = 1, DIN5 = 0 ⇒ FF3 (P043)
 (2) P053 < 17, P054 = 17, P055 = 17:
 DIN3 is fixed at zero (only FF5 to 8 available)
 e.g. DIN4 = 1, DIN5 = 0 ⇒ FF7 (P048)

P056	Digital input debounce time	0 – 2 [0]	0 = 12.5 ms 1 = 7.5 ms 2 = 2.5 ms The response time to a digital input = (debounce time + 7.5 ms).
------	-----------------------------	-----------	---

Parameter	Function	Range [Default]	Description / Notes
P061	Selection relay output RL1	0 – 13 [6]	

Value	Relay function	Active ³
0	No function assigned (relay not active)	Low
1	Inverter is running	High
2	Inverter frequency 0.0 Hz	Low
3	Motor running direction right	High
4	External brake on (see parameters P063/P064)	Low
5	Inverter frequency less than or equal to minimum frequency	Low
6	Fault indication ¹	Low
7	Inverter frequency greater than or equal to setpoint	High
8	Warning active ²	Low
9	Output current greater than or equal to P065	High
10	Motor current limit (warning) ²	Low
11	Motor over temperature (warning) ²	Low
12	Closed loop motor LOW speed limit	High
13	Closed loop motor HIGH speed limit	High

¹ Inverter switches off (see parameter P930 and section 6).

² Inverter does not switch off (see parameter P931).

³ 'Active low' = relay OFF. 'Active high' = relay ON.

Note: If the external brake function is used (P061 or P062 = 4) and additional slip compensation is used (P071 > 0), minimum frequency **must be less than 5 Hz** (P012 < 5.00), otherwise the inverter may not switch off reliably.

P062	Selection relay output RL2	0 – 13 [8]	Sets the relay function, output RL2 (terminals 19/20) (refer to the table in P061).
P063	External brake release delay (seconds)	0 – 20.0 [1.0]	Only effective if the relay output is set to control an external brake (P061 = 4). In this case when the inverter is switched on, it will run at the minimum frequency for the time set by this parameter before releasing the brake control relay and ramping up (see illustration in P064).
P064	External brake stopping time (seconds)	0 – 20.0 [1.0]	As P063, only effective if the relay output is set to control an external brake. This defines the period for which the inverter continues to run at the minimum frequency after ramping down and while the external brake is applied.

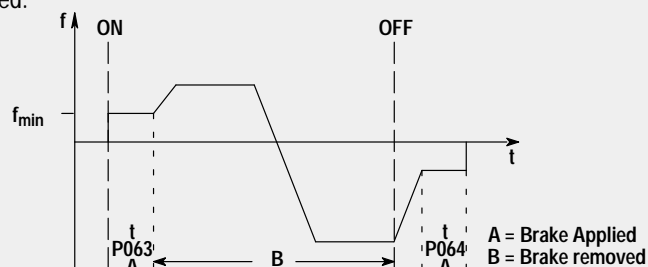

- Notes:**
- (1) Settings for P063 and P064 should be slightly longer than the actual time taken for the external brake to apply and release respectively.
 - (2) Setting P063 or P064 to too high a value, especially with P012 set to a high value, can cause an overcurrent warning or trip as the inverter attempts to move a locked motor shaft.

P065	Current threshold for relay (A)	0 – 99.9 [1.0]	This parameter is used when P061 = 9. The relay switches on when the motor current is greater than the value of P065 and switches off when the current falls to 90% of the value of P065 (hysteresis).
------	---------------------------------	-------------------	--

Parameter	Function	Range [Default]	Description / Notes
P070	Braking Resistor Duty Cycle (MICRO MASTER only)	0 – 4 [0]	<p>0 = 5% (as for previous MICRO MASTERS) 1 = 10% 3 = 50% 2 = 20% 4 = 100% (i.e. continuous)</p> <p>WARNING: Standard braking resistors for the MICRO MASTER are designed for the 5% duty cycle only. Do not select higher duty cycles unless suitably rated resistors are being used to handle the increased power dissipation.</p>
P071 •	Slip compensation (%)	0 – 200 [0]	<p>The inverter can estimate the amount of slip in an asynchronous motor at varying loads and increase its output frequency to compensate. This parameter 'fine tunes' the compensation for different motors in the range 0 – 200% of the calculated slip.</p> <p>WARNING: This parameter must be set to zero when using synchronous motors or motors that are connected in parallel. Over-compensation can cause instability.</p>
P072 •	Slip limit (%)	0 – 500 [250]	<p>This limits the slip of the motor to prevent 'pull-out' (stalling), which can occur if slip is allowed to increase indefinitely. When the slip limit is reached, the inverter reduces the frequency until the level of slip is below the limit.</p>
P073 •	DC injection braking (%)	0 – 250 [0]	<p>This stops the motor by applying a DC current. This causes heat to be generated in the motor rather than the inverter and holds the shaft stationary until the end of the braking period. Braking is effective for the period of time set by P003.</p> <p>The DC brake can be activated using DIN1 – DIN5 (see P051 – P055).</p> <p>WARNING: Frequent use of long periods of dc injection braking can cause the motor to overheat.</p> <p>If DC injection braking is enabled via a digital input then DC current is applied for as long as the digital input is high. This causes heat in the motor.</p>
P074 •	Motor derating curve as temperature protection	0 – 3 [0]	<p>Self-cooling fan ventilated motors tend to overheat at low speeds. This is because the current (and therefore the heat) generated in the motor is the same, but the rate of heat dissipation from the motor is only about 25% of normal when the fan is not running. It may be necessary, therefore, to derate a self-cooled motor at low speeds using this parameter. The internal I²t calculation allows a brief overload period (max. 1 minute at 150% of reduced value). The following derating curves are available:</p>

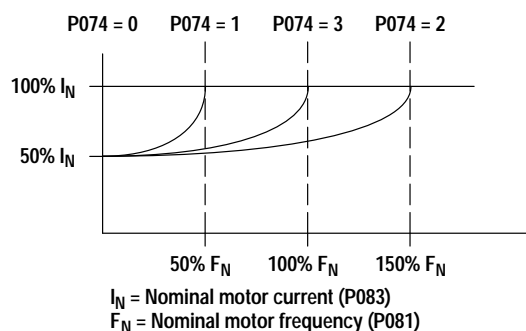

- 0 = No derating. Suitable for motors with separately powered cooling or no fan cooling which dissipate the same amount of heat regardless of speed.
- 1 = Normally suitable for 2-pole motors which generally have better cooling due to their higher speeds. The inverter assumes that the motor can dissipate full power at $\geq 50\%$ nominal frequency.
- 2 = Try this setting if the motor still runs too hot with P074 set to '3'.
- 3 = Suits most motors, full nominal power delivered at $\geq 100\%$ nominal frequency.

Parameter	Function	Range [Default]	Description / Notes																								
P075 •	Braking resistance (Ω) (MICRO MASTER only)	0/50 – 250 [0]	<p>An external braking resistor can be used to 'dump' the power generated by the motor, thus giving greatly improved braking capabilities. It MUST NOT be less than 50Ω (85Ω for 3 AC 400 V inverters) or the inverter will be damaged. Several purpose made resistors are available to cater for all MICRO and MIDI MASTER variants.</p> <p>WARNING: Take care if an alternative resistor is to be used as the pulsed voltage applied by the inverter can destroy ordinary resistors.</p> <p>Set P075 = 0 if an external braking resistor is not required.</p>																								
P076 •	Pulse frequency	0 – 10 [0 or 4]	<p>Sets the pulse frequency (from 2.44 to 16 kHz) and the PWM mode. If silent operation is not absolutely necessary, the losses in the inverter as well as the RFI emissions can be reduced by selecting lower pulse frequencies.</p> <p>Previously used modulation modes 1 and 2 are now combined and selected automatically by the inverter. Mode 3 randomises the pulse frequency to avoid resonance and can be used to reduce noise in the motor.</p> <p>0/1 = 16 kHz 2/3 = 8 kHz 4/5 = 4 kHz 6/7 = 2.44 kHz 8 = 8 – 16 kHz modulation mode 3 9 = 4 – 8 kHz modulation mode 3 10 = 2.44 – 4 kHz modulation mode 3</p> <p>Note: When P076 = 0/1, the display of the current at frequencies below 10 Hz is less accurate.</p> <p>Certain inverters may have their maximum continuous current (100%) derated if the value of P076 is changed from the default value to another value:</p> <table border="1"> <thead> <tr> <th rowspan="2">Model</th> <th colspan="4">P076 =</th> </tr> <tr> <th>0 or 1</th> <th>2 or 3</th> <th>8</th> <th>9</th> </tr> </thead> <tbody> <tr> <td>MM400/3</td> <td>60%</td> <td>80%</td> <td>80%</td> <td>90%</td> </tr> <tr> <td>MM550/3</td> <td>60%</td> <td>80%</td> <td>80%</td> <td>90%</td> </tr> <tr> <td>All MIDI MASTERS</td> <td>50%</td> <td>90%</td> <td>50%</td> <td>90%</td> </tr> </tbody> </table> <p>Notes: (1) If P076 = 4, 5, 6, 7 or 10 then derating does not occur on these inverters. (2) Changing the value of P076 may cause the values of P083 and/or P086 to be reduced automatically if these exceed the maximum derated value.</p>	Model	P076 =				0 or 1	2 or 3	8	9	MM400/3	60%	80%	80%	90%	MM550/3	60%	80%	80%	90%	All MIDI MASTERS	50%	90%	50%	90%
Model	P076 =																										
	0 or 1	2 or 3	8	9																							
MM400/3	60%	80%	80%	90%																							
MM550/3	60%	80%	80%	90%																							
All MIDI MASTERS	50%	90%	50%	90%																							

Parameter	Function	Range [Default]	Description / Notes
P077	Control mode	0 – 2 [1]	<p>Controls the relationship between the speed of the motor and the voltage supplied by the inverter. One of three modes can be selected:</p> <ul style="list-style-type: none"> 0 = Linear voltage/frequency Use this curve for synchronous motors or motors connected in parallel. 1 = Flux Current Control (FCC) In this mode the inverter makes real-time calculations of the required voltage by modelling the behaviour of the motor. This allows it to adjust the motor for full flux in all conditions. 2 = Quadratic voltage/frequency relationship This is suitable for pumps and fans.

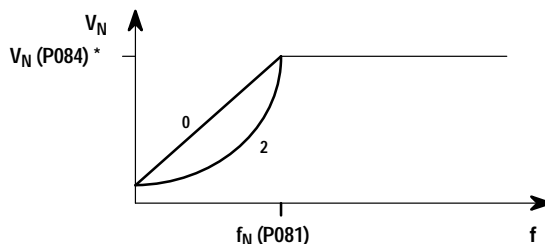

* Or up to maximum mains input voltage.

P078 •	Continuous boost (%)	0 – 250 [100]	<p>Operates continuously over the whole frequency range. For many applications it is necessary to increase low frequency torque. This parameter sets the start-up current at 0 Hz to adjust the available torque for low frequency operation. Range 0 – 250% of the motor current rating.</p> <p>WARNING: If P078 is set too high, overheating of the motor and/or an overcurrent trip (F002) can occur.</p>
P079 •	Starting boost (%)	0 – 250 [0]	<p>For drives which require a high initial starting torque, it is possible to set an extra voltage increase by boosting the starting current by 0 – 250% of the nominal motor current. This increase is only effective during initial start up and until the frequency setpoint is reached.</p> <p>Note: This increase is in addition to P078.</p>
P081	Nominal frequency for motor (Hz)	0 – 650.00 [50.00]	<p>These parameters must be set for the motor used. Read the specifications on the motor's rating plate (see Figure 14 in section 4.1).</p> <p>Note: The inverter's default settings vary according to the power rating.</p>
P082	Nominal speed for motor (RPM)	0 – 9999 [☆☆☆]	
P083	Nominal current for motor (A)	0.1 – 99.9 [☆☆☆]	
P084	Nominal voltage for motor (V)	0 – 1000 [☆☆☆]	
P085	Nominal power for motor (kW)	0 – 50.0 [☆☆☆]	
P086 •	Motor current limit (%)	0 – 250 [150]	<p>With this parameter the motor current can be limited and overheating of the motor prevented. If the set value is exceeded, the output frequency is reduced until the current falls below this limit. During this process the display flashes as a warning indication. The inverter does not trip, but you can make it trip by using the relay in conjunction with P074 to provide motor protection.</p> <p><i>MIDI MASTER inverters only:</i> The maximum value of P086 is reduced when a quadratic voltage/frequency is selected (P077 = 2). In this case the value of P086 will be limited automatically and its value may change from that entered. If P077 is reset to 0 or 1 then the value of P083 may also change.</p>

Parameter	Function	Range [Default]	Description / Notes
P087 •	Motor PTC enable	0 – 1 [0]	<p>0 = Disabled 1 = External PTC enabled</p> <p>Note: If P087 = 1 and the PTC input goes high then the inverter will trip (fault code F004 displayed). The relay will not operate unless it is set to a general fault (P061 = 6). If P061 = 11 then the relay operates as a warning if either the internal PTC gets hot (indicating high heatsink temperature) or if P074 is activated. Warning code 005 is written to P931 and the display flashes. Note that if the internal PTC gets too hot, the inverter will trip and F005 will be displayed.</p>
P088	Automatic calibration	0 – 1 [0]	<p>The stator resistance is used in the inverter's current monitoring calculations. This function allows the inverter to perform an automatic measurement of stator resistance, stores it in P089 and then resets P088 to '0'.</p> <p>If the measured resistance is too high for the size of inverter (e.g. motor not connected or unusually small motor connected), the inverter will trip (fault code F188) and will leave P088 set to '1'. If this happens, set P089 manually and then set P088 to '0'.</p>
P089 •	Stator resistance (Ω)	0.01 – 100.00 [☆☆☆]	<p>Can be used instead of P088 to set the stator resistance manually. The value entered should be the resistance between any two phases.</p> <p>Note: If the value of P089 is too high then an overcurrent trip (F002) may occur.</p>
P091 •	Slave address	0 – 30 [0]	Up to 31 inverters can be connected via the serial link and controlled by a computer or PLC using the USS protocol. This parameter sets a unique address for the inverter.
P092 •	Baud rate	3 – 7 [6]	<p>Sets the baud rate of the RS485 serial interface (USS protocol):</p> <p>3 = 1200 baud 4 = <i>Do not use</i> 5 = 4800 baud 6 = 9600 baud 7 = 19200 baud</p> <p>Note: Some RS232 to RS485 converters are not capable of baud rates higher than 4800.</p>
P093 •	Timeout (seconds)	0 – 240 [0]	<p>This is the maximum permissible period between two incoming data telegrams. This feature is used to turn off the inverter in the event of a communications failure.</p> <p>Timing starts after a valid data telegram has been received and if a further data telegram is not received within the specified time period, the inverter will trip and display fault code F008.</p> <p>Setting the value to zero switches off the control.</p>
P094 •	Serial link nominal system setpoint (Hz)	0 – 650.00 [50.00]	Setpoints are transmitted to the inverter via the serial link as percentages. The value entered in this parameter represents 100% (4000H).
P095 •	USS compatibility	0 – 2 [0]	<p>0 = Compatible with 0.1 Hz resolution 1 = Enable 0.01 Hz resolution 2 = PZD is not scaled but represents the actual frequency value to a resolution of 0.01 Hz (e.g. 5000 = 50 Hz).</p>
P101 •	Operation for Europe or USA	0 – 1 [0]	<p>This sets the inverter for European or USA supply and motor frequency:</p> <p>0 = Europe (50 Hz) 1 = USA (60 Hz)</p>
P111	Inverter power rating (kW/hp)	0.0 – 50.00 [☆☆☆]	<p>Read-only parameter that indicates the power rating of the inverter in kW. e.g. 0.55 = 550 W</p> <p>Note: If P101 = 1 then the rating is displayed in hp.</p>
P121	Enable/disable RUN button	0 – 1 [1]	<p>0 = RUN button disabled 1 = RUN button enabled (only possible if P007 = 1)</p>

Parameter	Function	Range [Default]	Description / Notes
P122	Enable/disable FORWARD/REVERSE button	0 – 1 [1]	0 = FORWARD/REVERSE button disabled 1 = FORWARD/REVERSE button enabled (only possible if P007 = 1)
P123	Enable/disable JOG button	0 – 1 [1]	0 = JOG button disabled 1 = JOG button enabled (only possible if P007 = 1)
P124	Enable/disable Δ and ∇ buttons	0 – 1 [1]	0 = Δ and ∇ buttons disabled 1 = Δ and ∇ buttons enabled (only possible if P007 = 1)
P131	Frequency setpoint (Hz)	0.00 – 650.00 [-]	Read-only parameters. These are copies of the values stored in P001 but can be accessed directly via the serial link.
P132	Motor current (A)	0.0 – 99.9 [-]	
P133	Motor torque (% nominal torque)	0 – 250 [-]	
P134	DC link voltage (V)	0 – 1000 [-]	
P135	Motor RPM	0 – 9999 [-]	
P201	Closed loop mode	0 – 2 [0]	0 = Normal operation (closed loop control disabled). 1 = Closed loop control using X503/X2 input. 2 = Closed loop control using X501/X1 input.
P202 •	P gain	0.0 – 999.9 [1.0]	Proportional gain.
P203 •	I gain	0.00 – 99.99 [0.00]	Integral gain.
P204 •	D gain	0.0 – 999.9 [0.0]	Derivative gain.
P205 •	Sample interval (x 25 ms)	1 – 2400 [1]	Sampling interval of feedback sensor.
P206 •	Sensor filtering	0 – 255 [0]	0 = Filter off. 1 – 255 = Low pass filtering applied to sensor.
P207 •	Integral capture range (%)	0 – 100 [100]	Percentage error above which integral term is reset to zero.
P208	Sensor type	0 – 1 [0]	0 = Increase motor speed as voltage/current increases. 1 = Decrease motor speed as voltage/current increases.
P210	Sensor reading (%)	0.0 – 100.00 [-]	Read only. Value is a percentage of full scale of the selected input (i.e. 5 V, 10 V or 20 mA).
P211 •	0% setpoint	0.0 – 100.00 [0.0]	Value of P210 to be maintained for 0% setpoint.
P212 •	100% setpoint	0.0 – 100.00 [100.00]	Value of P210 to be maintained for 100% setpoint.
P220	Minimum frequency mode	0 – 1 [0]	0 = Normal operation. 1 = Switch off motor voltage at or below minimum frequency. Note: Only to be used for PID control.

Parameter	Function	Range [Default]	Description / Notes
P720 •	Special input/output functions	0 – 7 [0]	Allows direct access to the relay outputs and the analogue output via the serial link (USS or PROFIBUS–DP with OPmP module): <ul style="list-style-type: none"> 0 = Normal operation 1 = Direct control of relay 1 2 = Direct control of relay 2 3 = Direct control of relay 1 and relay 2 4 = Direct control of analogue output only 5 = Direct control of analogue output and relay 1 6 = Direct control of analogue output and relay 2 7 = Direct control of analogue output, relay 1 and relay 2
P721	Analogue input voltage (V)	0.00 – 10.00 [-]	Displays the analogue input voltage (approximate).
P722 •	Analogue output current (mA)	0.0 – 20.0 [-]	Allows direct control of the output current if P720 = 4, 5, 6 or 7.
P723	State of digital inputs	0 – 31 [-]	Provides a decimal representation of a 5–digit binary number of which the LSB = DIN1 and the MSB = DIN5 (1 = ON, 0 = OFF). e.g. If P723 = '11', this represents '01011' – DIN1, DIN2 and DIN4 = ON, DIN3 and DIN5 = OFF.
P724 •	Relay output control	0 – 3 [0]	Enables control of the output relays. Used in conjunction with P720, e.g. setting P724 = 1 (relay 1 = ON) has no effect unless P720 = 1, 3, 5 or 7. <ul style="list-style-type: none"> 0 = Both relays OFF 1 = Relay 1 ON 2 = Relay 2 ON 3 = Both relays ON
P910 •	Local/Remote mode	0 – 4 [0]	Sets the inverter for local control or remote control over the serial link: <ul style="list-style-type: none"> 0 = Local control 1 = Remote control (and setting of parameter values) 2 = Local control (but remote control of frequency) 3 = Remote control (but local control of frequency) 4 = Local control (but remote read and write access to parameters and facility to reset trips) <p>Note: When operating the inverter via remote control (P910 = 1 or 3), the analogue input remains active when P006 = 1 and is added to the setpoint.</p>
P922	Software version	0 – 9999 [-]	Contains the software version number and cannot be changed.
P923 •	Equipment system number	0 – 255 [0]	You can use this parameter to allocate a unique reference number to the inverter. It has no operational effect.
P930	Most recent fault code	0 – 9999 [-]	The last recorded fault code (<i>see section 6</i>) is stored in this parameter. It is cleared when the inverter is reset.
P931	Most recent warning type	0 – 9999 [-]	The last recorded warning is stored in this parameter until power is removed from the inverter: <ul style="list-style-type: none"> 002 = Current limit active 003 = Voltage limit active 004 = Slip limit exceeded 005 = Motor overtemperature
P944	Reset to factory default settings	0 – 1 [0]	Set to '1' and then press P to reset all parameters except P101 to the factory default settings.
P971 •	EEPROM storage control	0 – 1 [1]	<ul style="list-style-type: none"> 0 = Changes to parameter settings are lost when power is removed. 1 = Changes to parameter settings are retained during periods when power is removed.

6. FAULT CODES

In the event of a failure, the inverter switches off and an error code appears on the display. The last error that occurred is stored in parameter P930. e.g. '0004' indicates that the last error was F004.

Fault Code	Cause	Corrective Action
F001	Overvoltage	Check whether supply voltage is within the limits indicated on the rating plate. Increase the ramp down time (P003) or apply braking resistor (option). Check whether the required braking power is within the specified limits.
F002	Overcurrent	Check whether the motor power corresponds to the inverter power. Check that the cable length limits have not been exceeded. Check motor lead and motor for short-circuits and earth faults. Check whether the motor parameters (P081 – P086) correspond with the motor being used. Check the stator resistance (P089). Increase the ramp-up time (P002). Reduce the boost set in P078 and P079. Check whether the motor is obstructed or overloaded.
F003	Overload	Check whether the motor is overloaded. Increase the maximum motor frequency if a motor with high slip is used.
F004	Overheating of motor (monitoring with PTC)	Check whether the motor is overloaded. Check the connections to the PTC. Check that P087 has not been set to '1' without a PTC being connected.
F005	Inverter overtemperature or motor overtemperature by I^2t calculation ¹	Check that the ambient temperature is not too high. Check that the air inlet and outlet are not obstructed. Check that the motor current does not exceed the value set in P083.
F006	Mains phase missing ² (3-phase units only)	Check the mains supply and correct.
F008	USS protocol timeout	Check the serial interface. Check the settings of the bus master and P091 – P093. Check whether the timeout interval is too short (P093).
F009	Undervoltage	Check the supply voltage.
F010	Initialisation fault ³	Check the entire parameter set. Set P009 to '0000' before power down.
F011	Internal interface fault ³	Switch off power and switch on again.
F013	Programme fault ³	Switch off power and switch on again.
F015	Failure to start on the fly	Try setting P016 to a different value.
F106	Parameter fault P006	Parameterise fixed frequency(ies) and/or motor potentiometer on the digital inputs.
F112	Parameter fault P012/P013	Set parameter P012 < P013.
F151 – F154	Digital input parameter fault	Change the settings of digital inputs P052 to P055.
F188	Automatic calibration failure	Motor not connected to inverter – connect motor. If the fault persists, set P088 = 0 and then enter the stator resistance of the motor into P089 manually.
F201	P006 = 1 while P201 = 2	Change parameter P006 and/or P201.
F212	Parameter fault P211/P212	Set parameter P211 < P212.

¹ This trip can only be reset by switching off the inverter and switching on again, even when the unit is cool.

² Only active on 3-phase 400 – 500 V MICRO MASTERS. It will only detect the missing phase when the inverter is operating at > 50% load.

³ Ensure that the wiring guidelines described in section 2.1 have been complied with.

When the fault has been corrected the inverter can be reset. To do this press button **P** twice (once to display P000 and the second time to reset the fault), or erase the fault via a binary input (see parameters P051 – P055 in section 5).

7. SUPPLEMENTARY INFORMATION

7.1 Application Example

Setup procedure for a simple application

Motor:	220 V 1.5 kW output power
Application requirements:	Setpoint adjustable via potentiometer 0 – 50 Hz Ramp up from 0 to 50 Hz in 15 seconds Ramp down from 50 to 0 Hz in 20 seconds
Inverter used:	MM150 (6SE3116–8BB40)
Settings:	P009 = 2 (all parameters can be altered) P081 – P085 = values given on motor rating plate P006 = 1 (analogue input) P002 = 15 (ramp up time) P003 = 20 (ramp down time)

This application is now to be modified as follows:

Operation of motor up to 75 Hz
(voltage/frequency curve is linear up to 50 Hz).
Motor potentiometer setpoint in addition to
analogue setpoint.
Use of analogue setpoint at maximum 10 Hz.

i.e.

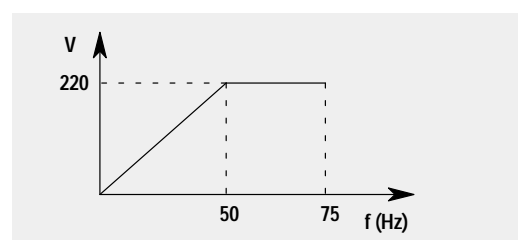

Parameter adjustments:	P009 = 2 (all parameters can be altered) P013 = 75 (maximum motor frequency in Hz) P006 = 2 (setpoint via motor potentiometer or fixed setpoint) P024 = 1 (analogue setpoint is added) P022 = 10 (maximum analogue setpoint at 10 V = 10 Hz)
------------------------	--

7.2 USS Status Codes

The following list gives the meaning of status codes displayed on the front panel of the inverter when the serial link is in use and parameter P001 is set to 006:

1	Message OK
2	Slave address received
100	Invalid start character
101	Timeout
102	Checksum error
103	Incorrect message length
104	Parity fail

Notes

- (1) The display flashes whenever a byte is received, thus giving a basic indication that a serial link connection is established.
- (2) If '100' flashes on the display continuously, this usually indicates a bus termination fault.

7.3 Electromagnetic Compatibility (EMC)

All manufacturers / assemblers of electrical apparatus which performs a complete intrinsic function which is placed on the market as a single unit intended for the end user must comply with the EMC directive EEC/89/336 after January 1996. There are three routes by which the manufacturer/assembler can demonstrate compliance:

1. Self-Certification

This is a manufacturer's declaration that the European standards applicable to the electrical environment for which the apparatus is intended have been met. Only standards which have been officially published in the Official Journal of the European Community can be cited in the manufacturer's declaration.

2. Technical Construction File

A technical construction file can be prepared for the apparatus describing its EMC characteristics. This file must be approved by a 'Competent Body' appointed by the appropriate European government organisation. This approach allows the use of standards which are still in preparation.

3. EC Type-Examination Certificate

This approach is only applicable to radio communication transmitting apparatus.

The MICRO and MIDI MASTER units do not have an intrinsic function until connected with other components (e.g. a motor). Therefore, the basic units are not allowed to be CE marked for compliance with the EMC directive. However, full details are provided below of the EMC performance characteristics of the products when they are installed in accordance with the wiring recommendations in section 2.1.

Three classes of EMC performance are available as detailed below. Note that these levels of performance are only achieved when using the default switching frequency (or less) and a maximum motor cable length of 25 m.

Class 1: General Industrial

Compliance with the EMC Product Standard for Power Drive Systems IEC 22G-WG4 (Cv) 21 for use in **Second Environment (Industrial)** and **Restricted Distribution**.

Note

Manufacturers/assemblers of electrical apparatus incorporating power drive systems who need to certify compliance with the EMC directive to their customers will need to produce a Technical Construction File (TCF) underwritten by a 'Competent Body' until the above power drive systems standard (IEC 22G-WG4 (Cv) 21) has been officially published in the Official Journal of the European Community. Once this has occurred, the self-certification route to compliance will be possible.

EMC Phenomenon	Standard	Level
<i>Emissions:</i>		
Radiated Emissions	EN 55011	Level A1 *
<i>Immunity:</i>		
Electrostatic Discharge	EN 61000-4-2	8 kV air discharge
Burst Interference	IEC 801-4	2 kV power cables, 1 kV control
Radio Frequency Electromagnetic Field	IEC 1000-4-3	26-1000 MHz, 10 V/m

* Limits not required inside a plant.

Class 2: Filtered Industrial

This level of performance will allow the manufacturer/assembler to self-certify their apparatus for compliance with the EMC directive for the industrial environment as regards the EMC performance characteristics of the power drive system. Performance limits are as specified in the Generic Industrial Emissions and Immunity standards EN 50081–2 and EN50082–2.

EMC Phenomenon	Standard	Level
<i>Emissions:</i>		
Radiated Emissions	EN 55011	Level A1 *
Conducted Emissions	EN 55011	Level A1 *
<i>Immunity:</i>		
Supply Voltage Distortion	IEC 1000–2–4 (1993)	
Voltage Fluctuations, Dips, Unbalance, Frequency Variations	IEC 1000–2–1	
Magnetic Fields	EN 61000–4–8	50 Hz, 30 A/m
Electrostatic Discharge	EN 61000–4–2	8 kV air discharge
Burst Interference	EN 61000–4–4	2 kV power cables, 2 kV control
Radio Frequency Electromagnetic Field, amplitude modulated	ENV 50 140	80–1000 MHz, 10 V/m, 80% AM, power and signal lines
Radio-frequency Electromagnetic Field, pulse modulated	ENV 50 204	900 MHz, 10 V/m 50% duty cycle, 200 Hz repetition rate

* Limits not required inside a plant.

Class 3: Filtered – for residential, commercial and light industry

This level of performance will allow the manufacturer / assembler to self-certify compliance of their apparatus with the EMC directive for the residential, commercial and light industrial environment as regards the emc performance characteristics of the power drive system. Performance limits are as specified in the generic emission and immunity standards EN 50081–1 and EN 50082–1.

EMC Phenomenon	Standard	Level
<i>Emissions:</i>		
Radiated Emissions	EN 55022	Level B1
Conducted Emissions	EN 55022	Level B1
<i>Immunity:</i>		
Electrostatic Discharge	IEC 801–2:1984	8 kV air discharge
Burst Interference	IEC 801–4:1988	1 kV power cables, 0.5 kV control

Note

The MICRO and MIDI MASTER products are intended **exclusively for professional applications**. Therefore, they do not fall within the scope of the harmonics emissions specification EN 60 555–2.

Compliance Table:

Model No.	EMC Class
MM25 – MM220	Class 2
MM25/2 – MM300/2	Class 1
MM25/2 – MM220/2 with external filter (see table) <i>1 phase input only</i>	Class 2*
MM25/2 – MM220/2 with external filter and metallised cover (see table) <i>1 phase input only</i>	Class 3
MM150/3 – MM550/3	Class 1
MM150/3 – MM550/3 with external filter (see table)	Class 2*
MM150/3 – MM550/3 with external filter and metallised cover (see table)	Class 3
MD550/2 – MD2200/2	Class 1
MD750/3 – MD3700/3	Class 1
MD750/3 – MD3700/3 with external filter (see table)	Class 2*
MD750/3 – MD3700/3 with external filter and metallised cover (see table)	Class 3
MD750/4 – MD3700/4	Class 1

* If the installation of the inverter reduces the radio frequency field emissions (e.g. by installation in a steel enclosure), Class 3 limits will typically be met.

Filter Part Numbers:

Model No.	Filter Part No.	Standard
MM25/2 – MM75/2	6SE3090-0BA07-0FB1	EN 55011 / EN 55022
MM110/2 – MM220/2	6SE3090-0BC07-0FB1	EN 55011 / EN 55022
MM150/3 – MM550/3	6SE3190-0DC87-0FB1	EN 55011 / EN 55022
MD750/3 – MD1850/3	6SE2100-1FC20	EN 55011 / EN 55022
MD2200/3 – MD3700/3	6SE2100-1FC21	EN 55011 / EN 55022

EMC Filter / Metallised Cover Kits:

Model No.	Filter + Cover Part No.	Cover Part No.	Standard
MM25/2 – MM75/2	6SE3190-0BA87-0FB0	–	EN 55022 class B1
MM110/2 – MM150/2	6SE3190-0BB87-0FB0	–	EN 55022 class B1
MM220/2	6SE3190-0BC87-0FB0	–	EN 55022 class B1
MM150/3 – MM550/3	6SE3190-0DC87-0FB0	–	EN 55022 class B1
MD750/3 – MD1100/3	–	6SE3190-0DG87-0FC0	
MD1500/3 – MD1850/3	–	6SE3190-0DH87-0FC0	
MD2200/3 – MD3700/3	–	6SE3190-0DJ87-0FC0	

7.4 European Low Voltage Directive

The MICRO and MIDI MASTER product ranges comply with the requirements of the Low Voltage Directive 73/23/EEC. The units are certified for compliance with the following standards:

- EN 60204-1 Safety of machinery – Electrical equipment of machines
- EN 60146-1-1 Semiconductor converters – General requirements and line commutated converters

7.5 European Machinery Directive

The MICRO and MIDI MASTER inverter series does not fall under the scope of the Machinery Directive. However, the products have been fully evaluated for compliance with the essential Health & Safety requirements of the directive when used in a typical machine application. A Declaration of Incorporation is available on request.

7.6 Technical Terms

Baud	A unit of measure for the speed of data transmission named after Jean Baudot. One Baud corresponds to one bit per second (bps).
CPU	Abbreviation for C entral P rocessing U nit of a computer.
FCC	F lux C urrent C ontrol for optimum motor efficiency and high dynamic range.
4 Q Control	Four quadrant control of a motor, driving and braking in both directions.
Interface	The means by which a micro-computer can be connected to other components.
NEMA	Abbreviation for N ational E lectrical M anufacturers' A ssociation.
PLC	Abbreviation for P rogrammable L ogic C ontroller.
PTC	Abbreviation for P ositive T emperature C oefficient. The resistance of which increases if the temperature rises.
PWM	P ulse W idth M odulation.
RS485	R ecommended S tandard. Recommended standard for computer interfaces.
Status Information	Identification of the status in data processing.
USS Protocol	U niver S al S erial interface protocol.

7.7 Parameter Summary List

- = Parameter can be changed during operation.
- ☆☆☆ = Value depends on the rating of the inverter.

Parameter	Function	Range [Default]	Parameter	Function	Range [Default]
P000	Operating display	–	P034 •	Jog ramp down time (seconds)	0 – 650.0 [10.0]
P001 •	Display selection	0 – 7 [0]	P041 •	1st fixed frequency (Hz)	0 – 650.00 [5.00]
P002 •	Ramp up time (seconds)	0 – 650.0 [10.0]	P042 •	2nd fixed frequency (Hz)	0 – 650.00 [10.00]
P003 •	Ramp down time (seconds)	0 – 650.0 [10.0]	P043 •	3rd fixed frequency (Hz)	0 – 650.00 [20.00]
P004 •	Smoothing (seconds)	0 – 40.0 [0.0]	P044 •	4th fixed frequency (Hz)	0 – 650.00 [40.00]
P005 •	Digital frequency setpoint (Hz)	0 – 650.00 [0.00]	P045	Inversion fixed setpoints 1 – 4	0 – 7 [0]
P006	Frequency setpoint type selection	0 – 2 [0]	P046 •	5th fixed frequency (Hz)	0 – 650.00 [0.00]
P007	Enable/disable front panel buttons	0 – 1 [1]	P047 •	6th fixed frequency (Hz)	0 – 650.00 [0.00]
P009 •	Parameter protection setting	0 – 3 [0]	P048 •	7th fixed frequency (Hz)	0 – 650.00 [0.00]
P010	Display scaling	0 – 500.00 [1.00]	P049 •	8th fixed frequency (Hz)	0 – 650.00 [0.00]
P011	Frequency setpoint memory	0 – 1 [0]	P050	Inversion fixed setpoints 5 – 8	0 – 7 [0]
P012 •	Minimum motor frequency (Hz)	0 – 650.00 [0.00]	P051	Selection control function, DIN1 (terminal 8), fixed frequency 5	0 – 18 [1]
P013 •	Maximum motor frequency (Hz)	0 – 650.00 [50.00]	P052	Selection control function, DIN2 (terminal 9), fixed frequency 4	0 – 18 [2]
P014 •	Skip frequency (Hz)	0 – 650.00 [0.00]	P053	Selection control function, DIN3 (terminal 10), fixed frequency 3	0 – 18 [6]
P015 •	Automatic restart	0 – 1 [0]	P054	Selection control function, DIN4 (terminal 11), fixed frequency 2	0 – 18 [6]
P016 •	Start on the fly	0 – 4 [0]	P055	Selection control function, DIN5 (terminal 12), fixed frequency 1	0 – 18 [6]
P017 •	Smoothing type	1 – 2 [1]	P056	Digital input debounce time	0 – 2 [0]
P018 •	Automatic restart after fault	0 – 1 [0]	P061	Selection relay output RL1	0 – 13 [6]
P021 •	Minimum analogue frequency (Hz)	0 – 650.00 [0.00]	P062	Selection relay output RL2	0 – 13 [8]
P022 •	Maximum analogue frequency (Hz)	0 – 650.00 [50.00]	P063	External brake release delay (seconds)	0 – 20.0 [1.0]
P023 •	Analogue input type	0 – 2 [0]	P064	External brake stopping time (seconds)	0 – 20.0 [1.0]
P024 •	Analogue setpoint addition	0 – 2 [0]	P065	Current threshold for relay (A)	0 – 99.9 [1.0]
P025 •	Analogue output	0 – 105 [0]	P070	Braking Resistor Duty Cycle (MICRO MASTER only)	0 – 4 [0]
P031 •	Jog frequency right (Hz)	0 – 650.00 [5.00]	P071 •	Slip compensation (%)	0 – 200 [0]
P032 •	Jog frequency left (Hz)	0 – 650.00 [5.00]	P072 •	Slip limit (%)	0 – 500 [250]
P033 •	Jog ramp up time (seconds)	0 – 650.0 [10.0]			

continued over

MICRO MASTER and MIDI MASTER

Operating Instructions

Parameter	Function	Range [Default]	Parameter	Function	Range [Default]
P073	• DC injection braking (%)	0 – 250 [0]	P132	Motor current (A)	0.0 – 99.9 [-]
P074	• Motor derating curve as temperature protection	0 – 3 [0]	P133	Motor torque (% nominal torque)	0 – 250 [-]
P075	• Braking resistance (Ω) (MICRO MASTER only)	0/50 – 250 [0]	P134	DC link voltage (V)	0 – 1000 [-]
P076	• Pulse frequency	0 – 10 [0 or 4]	P135	Motor RPM	0 – 9999 [-]
P077	Control mode	0 – 2 [1]	P201	Closed loop mode	0 – 2 [0]
P078	• Continuous boost (%)	0 – 250 [100]	P202	• P gain	0 – 999.9 [1.0]
P079	• Starting boost (%)	0 – 250 [0]	P203	• I gain	0 – 99.99 [0.00]
P081	Nominal frequency for motor (Hz)	0 – 650.00 [50.00]	P204	• D gain	0 – 999.9 [0.0]
P082	Nominal speed for motor (RPM)	0 – 9999 [☆☆☆☆]	P205	• Sample interval (x 25 ms)	1 – 2400 [1]
P083	Nominal current for motor (A)	0.1 – 99.9 [☆☆☆☆]	P206	• Sensor filtering	0 – 255 [0]
P084	Nominal voltage for motor (V)	0 – 1000 [☆☆☆☆]	P207	• Integral capture range (%)	0 – 100 [100]
P085	Nominal power for motor (kW)	0 – 50.0 [☆☆☆☆]	P208	Sensor type	0 – 1 [0]
P086	• Motor current limit (%)	0 – 250 [150]	P210	Sensor reading (%)	0 – 100.00 [-]
P087	• Motor PTC enable	0 – 1 [0]	P211	• 0% setpoint	0 – 100.00 [0.0]
P088	Automatic calibration	0 – 1 [0]	P212	• 100% setpoint	0 – 100.00 [100.00]
P089	• Stator resistance (Ω)	0.01 – 100.00 [☆☆☆☆]	P220	Minimum frequency mode	0 – 1 [100.00]
P091	• Slave address	0 – 30 [0]	P720	• Special input/output functions	0 – 7 [0]
P092	• Baud rate	3 – 7 [6]	P721	Analogue input voltage (V)	0.00 – 10.00 [-]
P093	• Timeout (seconds)	0 – 240 [0]	P722	• Analogue output current (mA)	0.0 – 20.0 [-]
P094	• Serial link nominal system setpoint (Hz)	0 – 650.00 [50.00]	P723	State of digital inputs	0 – 31 [-]
P095	• USS compatibility	0 – 2 [0]	P724	• Relay output control	0 – 3 [0]
P101	• Operation for Europe or USA	0 – 1 [0]	P910	• Local/Remote mode	0 – 4 [0]
P111	Inverter power rating (kW/hp)	0.0 – 50.0 [☆☆☆☆]	P922	Software version	0 – 9999 [-]
P121	Enable/disable RUN button	0 – 1 [1]	P923	• Equipment system number	0 – 255 [0]
P122	Enable/disable FORWARD/REVERSE button	0 – 1 [1]	P930	Most recent fault code	0 – 9999 [-]
P123	Enable/disable JOG button	0 – 1 [1]	P931	Most recent warning type	0 – 9999 [-]
P124	Enable/disable Δ and ∇ buttons	0 – 1 [1]	P944	Reset to factory default settings	0 – 1 [0]
P131	Frequency setpoint (Hz)	0 – 650.00 [-]	P971	• EEPROM storage control	0 – 1 [1]

7.8 User's Parameter Settings

Record your own parameter settings in the table below:

Parameter	Your setting	Default	Parameter	Your setting	Default	Parameter	Your setting	Default
P000		–	P050		0	P101		0
P001		0	P051		1	P111		☆☆☆
P002		10.0	P052		2	P121		1
P003		10.0	P053		6	P122		1
P004		0.0	P054		6	P123		1
P005		0.00	P055		6	P124		1
P006		0	P056		0	P131		–
P007		1	P061		6	P132		–
P009		0	P062		8	P133		–
P010		1.00	P063		1.0	P134		–
P011		0	P064		1.0	P135		–
P012		0.00	P065		1.0	P201		0
P013		50.00	P070		0	P202		1.0
P014		0.00	P071		0	P203		0.00
P015		0	P072		250	P204		0.0
P016		0	P073		0	P205		1
P017		1	P074		0	P206		0
P018		0	P075		0	P207		100
P021		0.00	P076		0/4	P208		0
P022		50.00	P077		1	P210		–
P023		0	P078		100	P211		0.0
P024		0	P079		0	P212		100.00
P025		0	P081		50.00	P220		100.00
P031		5.00	P082		☆☆☆	P720		0
P032		5.00	P083		☆☆☆	P721		–
P033		10.0	P084		☆☆☆	P722		–
P034		10.0	P085		☆☆☆	P723		–
P041		5.00	P086		150	P724		0
P042		10.00	P087		0	P910		0
P043		20.00	P088		0	P922		–
P044		40.00	P089		☆☆☆	P923		0
P045		0	P091		0	P930		–
P046		0.00	P092		6	P931		–
P047		0.00	P093		0	P944		0
P048		0.00	P094		50.00	P971		1
P049		0.00	P095		0			

☆☆☆ = Value depends on the rating of the inverter.